



**ROHDE & SCHWARZ**

Test and Measurement  
Division

## **Operating Manual**

# **Power Reflection Meter**

# **NRT**

**1080.9506.02/.62**

Printed in the Federal  
Republic of Germany



---

## About this Manual

This operating manual is valid for NRT power reflection meters with firmware version **2.21** and sensors NRT-Z43/44 with firmware version **1.38** or higher.

If sensors with an earlier firmware version are used the modulation correction (see section 2.4.3) and attenuation correction (see section 2.4.4) are not available. Instead, the parameter list for the video bandwidth setting contains the entry "spread spectrum". The function of this entry is similar to the modulation correction; for details refer to the sensor manuals.



## Tabbed Divider Overview

### Contents

#### Data Sheet

Safety Instructions  
Certificate of Quality  
EC-Certificate of Conformity  
Support Center Address  
List of R&S Representatives

#### Tabbed Divider

<b>1</b>	<b>Chapter 1: Preparation for Use</b>
<b>2</b>	<b>Chapter 2: Manual Operation</b>
<b>3</b>	<b>Chapter 3: Remote Control</b>
<b>4</b>	<b>Chapter 4: Maintenance and Troubleshooting</b>
<b>5</b>	<b>Chapter 5: Testing the Rated Specifications</b>
<b>6</b>	<b>Annex A: Interfaces</b>
<b>7</b>	<b>Annex B: List of Error Messages</b>
<b>8</b>	<b>Annex C: List of Commands</b>
<b>9</b>	<b>Annex D: Programming Examples</b>
<b>10</b>	<b>Annex E: Default Settings</b>
<b>10</b>	<b>Index</b>



# Contents

## 1 Preparation for Use

<b>1.1</b>	<b>Front and Rear View</b> (see next two pages) .....	<b>1.1</b>
<b>1.2</b>	<b>Putting into Operation</b> .....	<b>1.1</b>
1.2.1	Unpacking .....	1.1
1.2.2	Setting Up.....	1.1
1.2.3	Rackmounting .....	1.4
1.2.4	Connection to AC Supply .....	1.4
1.2.5	Power Fuses .....	1.5
1.2.6	Power Up.....	1.5
1.2.7	Connecting a Sensor to the NRT .....	1.5
1.2.8	Switching Sensor into RF Circuit.....	1.6
1.2.9	EMC Shielding Measures .....	1.6
1.2.10	Function/Power-Up Test.....	1.6
<b>1.3</b>	<b>Installation of Options</b> .....	<b>1.7</b>
<b>1.4</b>	<b>Battery Operation (with Option NRT-B3)</b> .....	<b>1.8</b>
1.4.1	General.....	1.8
1.4.2	Charging the Battery.....	1.8
1.4.3	Manual Start/Stop of Battery Charging.....	1.9
1.4.4	Reducing the Power Consumption.....	1.10
1.4.5	Preselection of ON Period.....	1.11
1.4.6	Battery Counter .....	1.11
1.4.7	Replacing the Battery .....	1.12

## 2 Manual Operation

<b>2.1</b>	<b>Short Introduction</b> .....	<b>2.1</b>
2.1.1	Correct Connection of Sensor .....	2.1
2.1.2	Default Setup.....	2.1
2.1.3	Measuring the Power.....	2.2
2.1.3.1	Unit Selectable in W or dBm .....	2.2
2.1.3.2	Measuring Relative Power Differences .....	2.2
2.1.3.3	Measuring Envelope Parameters (ENV) .....	2.3
2.1.4	Measuring the Reflection.....	2.4
2.1.4.1	Switching between SWR and another Reflection Parameter .....	2.4
2.1.4.2	(De)activating the Acoustic Monitoring .....	2.4
2.1.5	Fixing the Display Range and Scaling.....	2.4

2.1.6	Enhanced Measurement Accuracy .....	2.5
2.1.6.1	Using Frequency Response Correction.....	2.5
2.1.6.2	Zeroing .....	2.7
2.1.6.3	Increasing the Measurement Accuracy for Modulated Signals .....	2.7
2.1.6.4	Selecting Forward Power ( <i>FWD</i> ) or Absorbed Power ( <i>F-R</i> ) .....	2.8
2.1.6.5	Reference Plane and Cable Losses .....	2.8
2.1.7	Measurement with Several Sensors.....	2.9
<b>2.2</b>	<b>Basic Operating Functions.....</b>	<b>2.10</b>
2.2.1	Front-Panel Keys.....	2.10
2.2.2	Operation via Function Keys .....	2.11
2.2.3	Scaling of Bargraphs and Underrange Identification.....	2.12
2.2.4	Selection of the Active Sensor .....	2.12
2.2.5	Menu Operation.....	2.13
2.2.5.1	Types of Menu Parameters .....	2.13
2.2.5.2	Numeric Entries .....	2.14
2.2.5.3	Menus and Notation .....	2.15
<b>2.3</b>	<b>CONFig Menu.....</b>	<b>2.16</b>
2.3.1	ENV KEY (Selection of Envelope Parameters) .....	2.17
2.3.1.1	Measurement of Peak Envelope Power .....	2.18
2.3.1.2	Crest Factor.....	2.19
2.3.1.3	Average Burst Power.....	2.20
2.3.1.4	Cumulative Distribution Function.....	2.22
2.3.2	POWER (Configuration of Power Display) .....	2.23
2.3.3	MAXHOLD (min/max display on/off) .....	2.23
2.3.4	MAXDISP (display of max value, min value or difference).....	2.24
2.3.5	SCALE (Setting of Scale Limits for Bargraphs).....	2.24
2.3.6	RESOL (Resolution of Indication in Display) .....	2.25
2.3.7	INT.TIME (Setting the Integration Time) .....	2.26
2.3.7.1	USER (Entry of a User-Defined Integration Time) .....	2.26
2.3.8	SPEC (Special Functions).....	2.27
2.3.8.1	$\Delta$ REF (Reference Value for Relative Power Measurements).....	2.27
2.3.8.2	SWR.ALARM (SWR Monitoring).....	2.27
2.3.9	$\Delta$ KEY (Configuration of Relative Units) .....	2.28
2.3.10	RFL KEY (Configuration of Reflection Indication) .....	2.29
<b>2.4</b>	<b>CORRection Menu.....</b>	<b>2.30</b>
2.4.1	FREQ (Frequency Response Correction ) .....	2.31
2.4.1.1	Entry of Carrier Frequency for NRT Sensors .....	2.31
2.4.1.2	Entry of Carrier Frequency for NAP Sensors .....	2.32
2.4.2	ZERO (Zeroing).....	2.32
2.4.3	MODULATION (correction of measured values with modulated signals).....	2.33
2.4.4	MEAS.POS (Definition of Reference Plane) .....	2.34



2.4.5	DIRECTION (Selection of Forward Power Direction).....	2.36
2.4.6	CALDATA (Entry of Calibration Factors).....	2.37
<b>2.5</b>	<b>UTILity Menu .....</b>	<b>2.39</b>
2.5.1	ILLUM (Switching off and on the Backlighting of the Display).....	2.40
2.5.2	SETUP (Recalling and Storing Instrument Settings).....	2.40
2.5.3	AUTO.OFF (Power-Saving Mode) .....	2.41
2.5.4	BATT.TIME (Battery Charging) .....	2.42
2.5.5	AFTER CHARGE (Automatic Switchoff after Charging) .....	2.42
2.5.6	BATTERY CHARGE (Manual Control of Battery Charging).....	2.43
2.5.7	BEEPER (Alarm Message, Acknowledge Signal) .....	2.43
2.5.8	REMOTE (Remote-Control Settings).....	2.44
2.5.9	AUX/IO (Configuration of IN/OUT Connector).....	2.45
2.5.9.1	Configuration as a Monitoring Output: Selection of Bargraph .....	2.46
2.5.9.2	Entering the Monitoring Criteria .....	2.46
2.5.9.3	Selection of Output Level for SWR Alarm .....	2.47
2.5.10	SHOW (Display of Correction Frequency and/or Cable Loss) .....	2.48
2.5.11	TEST (Built-in Tests).....	2.48
2.5.12	ELAPSED TIME (Elapsed Time Meter).....	2.49
2.5.13	KEYBOARD LOCK.....	2.50

### 3 Remote Control

<b>3.1</b>	<b>Brief Instructions.....</b>	<b>3.1</b>
3.1.1	IEC/IEEE-bus .....	3.1
3.1.2	RS-232 Interface .....	3.2
<b>3.2</b>	<b>Switchover to Remote Control.....</b>	<b>3.3</b>
3.2.1	Remote Control via IEC Bus .....	3.3
3.2.1.1	Setting the Device Address .....	3.3
3.2.1.2	Indications during Remote Control .....	3.3
3.2.1.3	Return to Manual Operation .....	3.4
3.2.2	Remote Control via RS-232-Interface .....	3.4
3.2.2.1	Setting the Transmission Parameters .....	3.4
3.2.2.2	Indications during Remote Control .....	3.4
3.2.2.3	Return to Manual Operation .....	3.5
<b>3.3</b>	<b>Messages .....</b>	<b>3.5</b>
3.3.1	Interface Message.....	3.5
3.3.2	Device Messages (Commands and Device Responses).....	3.5
<b>3.4</b>	<b>Structure and Syntax of the Device Messages.....</b>	<b>3.6</b>
3.4.1	SCPI Introduction .....	3.6
3.4.2	Structure of a Command .....	3.6

3.4.3	Structure of a Command Line .....	3.9
3.4.4	Responses to Queries.....	3.9
3.4.5	Parameters.....	3.10
3.4.6	Overview of Syntax Elements.....	3.12
<b>3.5</b>	<b>Description of Commands.....</b>	<b>3.13</b>
3.5.1	Notation .....	3.13
3.5.2	Trigger and Measurement during Remote Control.....	3.15
3.5.3	Selection of Measurement Channel .....	3.17
3.5.4	Common Commands .....	3.18
3.5.5	Measurement Instructions .....	3.20
3.5.6	CALCulate Subsystem .....	3.21
3.5.7	CALibration Subsystem.....	3.22
3.5.8	CONTrol Subsystem .....	3.24
3.5.9	DIAGnostic Subsystem .....	3.25
3.5.10	INPut Subsystem.....	3.26
3.5.11	SENSE Subsystem .....	3.28
3.5.12	STATus Subsystem.....	3.38
3.5.13	SYSTem Subsystem .....	3.40
3.5.14	TEST Subsystem .....	3.42
3.5.15	TRIGger Subsystem.....	3.44
3.5.16	UNIT Subsystem .....	3.45
<b>3.6</b>	<b>Instrument Model and Command Processing.....</b>	<b>3.47</b>
3.6.1	Input Unit .....	3.47
3.6.2	Command Recognition.....	3.48
3.6.3	Data Set and Instrument Hardware.....	3.48
3.6.4	Status Reporting System.....	3.48
3.6.5	Output Unit .....	3.49
3.6.6	Command Sequence and Command Synchronization .....	3.49
<b>3.7</b>	<b>Status Reporting System.....</b>	<b>3.50</b>
3.7.1	Structure of an SCPI Status Register.....	3.50
3.7.2	Overview of the Status Registers .....	3.52
3.7.3	Description of the Status Registers .....	3.53
3.7.3.1	Status Byte (STB) and Service Request Enable Register (SRE) .....	3.53
3.7.3.2	IST Flag and Parallel Poll Enable Register (PPE) .....	3.54
3.7.3.3	Event Status Register (ESR) and Event Status Enable Register (ESE) .....	3.54
3.7.3.4	STATus:OPERation Register .....	3.55
3.7.3.5	STATus:QUEStionable Register .....	3.55
3.7.4	Application of the Status Reporting Systems .....	3.56
3.7.4.1	Service Request, Making Use of the Hierarchy Structure .....	3.56

3.7.4.2 Serial Poll.....	3.57
3.7.4.3 Parallel Poll.....	3.57
3.7.4.4 Query by Means of Commands.....	3.57
3.7.4.5 Error Queue Query.....	3.57
3.7.5 Reset Values of the Status Reporting Systems .....	3.58

## 4 Maintenance and Troubleshooting

<b>4.1 Maintenance.....</b>	<b>4.1</b>
4.1.1 Cleaning the Outside.....	4.1
4.1.2 Replacing the Battery (Option NRT-B3) .....	4.1
4.1.3 Storage.....	4.2
<b>4.2 Firmware Update .....</b>	<b>4.3</b>
4.2.1 Loading New Firmware into Basic Unit .....	4.3
<b>4.3 Functional Test.....</b>	<b>4.8</b>
<b>4.4 Troubleshooting.....</b>	<b>4.8</b>
4.4.1 Detection of Faulty Module.....	4.8
<b>4.5 Installation and Removal of Modules.....</b>	<b>4.10</b>
4.5.1 Opening the Instrument.....	4.10
4.5.2 Option NRT-B1.....	4.11
4.5.3 Option NRT-B2.....	4.11
4.5.4 Option NRT-B3.....	4.12
4.5.5 Power Supply .....	4.13
4.5.6 Display Board.....	4.14
4.5.7 Mainboard.....	4.14

## 5 Checking the Rated Specifications

<b>5.1 Measuring Equipment and Accessories .....</b>	<b>5.1</b>
5.1.1 Test Setup for Checking the Option NRT-B1 .....	5.2
<b>5.2 Test Procedure .....</b>	<b>5.2</b>
5.2.1 Switch-On Sequence.....	5.2
5.2.2 Display and Keypad.....	5.2
5.2.2.1 Display Test.....	5.2
5.2.2.2 Keypad Test.....	5.3
5.2.2.3 Acoustic Signal Device .....	5.3
5.2.2.4 Memory Test.....	5.3
5.2.3 Remote Control .....	5.3
5.2.3.1 IEC/IEEE BUS (IEC625 / IEEE488 Interface) .....	5.3
5.2.3.2 RS232 Interface.....	5.4
5.2.4 Sensor Interface.....	5.4

5.2.5	AUX Interface .....	5.4
5.2.6	Option NRT-B1 .....	5.5
5.2.6.1	Sensor Identification .....	5.5
5.2.6.2	Zeroing .....	5.5
5.2.6.3	Power Measurement .....	5.6
5.2.7	Option NRT-B2.....	5.6
5.2.8	Option NRT-B3.....	5.6
5.2.8.1	Switchover AC Supply/Battery Operation .....	5.6
5.2.8.2	Battery Identification .....	5.7
5.2.8.3	Automatic Switch-Off of Charging .....	5.7
<b>5.3</b>	<b>Test Report.....</b>	<b>5.8</b>

**Annex A Interfaces**

<b>Annex A.1</b>	<b>IEC/IEEE Bus Interface.....</b>	<b>A.1</b>
Annex A.1.1	Characteristics of the Interface .....	A.1
Annex A.1.2	Bus Lines .....	A.1
Annex A.1.3	Interface Functions .....	A.2
Annex A.1.4	Interface Messages.....	A.3
<b>Annex A.2</b>	<b>RS-232-C Interface .....</b>	<b>A.4</b>
Annex A.2.1	Interface characteristics .....	A.4
Annex A.2.2	Signal lines.....	A.4
Annex A.2.3	Transmission parameters .....	A.5
Annex A.2.4	Interface functions.....	A.5
Annex A.2.5	Handshake.....	A.5

**Annex B List of Error Messages**

<b>Annex B.1</b>	<b>SCPI-Specific Error Messages.....</b>	<b>B.1</b>
<b>Annex B.2</b>	<b>NRT-Specific Error Messages.....</b>	<b>B.8</b>

**Annex C List of Commands**

**Annex D Programming Examples**

<b>Annex D.1</b>	<b>Including IEC-Bus Library for QuickBasic.....</b>	<b>D.1</b>
<b>Annex D.2</b>	<b>Initialization and Default Status.....</b>	<b>D.1</b>
Annex D.2.1	Initialize Controller .....	D.1
Annex D.2.2	Functions for Receiving and Sending Data and Commands.....	D.1
Annex D.2.3	Initialize the Instrument.....	D.2
<b>Annex D.3</b>	<b>Sending Device Setting Commands.....</b>	<b>D.2</b>

**Annex D.4** Switchover to Manual Control .....D.2

**Annex D.5** Reading out Device Settings.....D.3

**Annex D.6** Performing a measurement.....D.3

**Annex D.7** Command Synchronization.....D.4

**Annex D.8** Service Request .....D.5

**Annex E**    **Default Settings**

**Index**

# Figures

Fig. 1-1	Front view - display .....	1.2
Fig. 1-2	Rear view .....	1.3
Fig. 1-3	Replacing the battery .....	1.12
Fig. 2-1	Front-panel keys .....	2.10
Fig. 2-2	CONFig menu .....	2.16
Fig. 2-3	Envelope parameters with burst signal used as an example .....	2.17
Fig. 2-4	Effect of video bandwidth on indicated peak envelope power .....	2.18
Fig. 2-5	Average burst power .....	2.20
Fig. 2-6	CORRection menu .....	2.30
Fig. 2-7	Definition of the measurement position .....	2.35
Fig. 2-8	UTILity menu .....	2.39
Fig. 3-1	Example for the tree structure of the SCPI command systems: The SENSE system .....	3.7
Fig. 3-2	Instrument model in the case of remote control by means of the IEC bus .....	3.47
Fig. 3-3	The status register model .....	3.50
Fig. 3-4	The status registers .....	3.52
Fig. 4-1	Insertion and removal of battery .....	4.1
Fig. 4-2	Switching on the NRT for loading the firmware .....	4.4
Fig. 4-3	Removing the top and bottom cover .....	4.10
Fig. 4-4	Removing the cover plates for options NRT-B1 and NRT-B3 .....	4.11
Fig. 4-5	Installation of options NRT-B1, NRT-B2 and NRT-B3 .....	4.12
Fig. 4-6	Installation and removal of power supply, display board and Mainboard .....	4.13
Fig. A-1	Pin Assignment of the IEC-bus interface .....	A.1
Fig. A-2	Pin assignment of the RS-232-C interface .....	A.4
Fig. A-3	Null modem connection scheme .....	A.6

## Tables

Table 2-1	Setting the video bandwidths for the PEP, CF, and CCDF measurement functions.....	2.19
Table 3-1	Common Commands .....	3.18
Table 3-2	Device Response to *OPT?.....	3.19
Table 3-4	CALCulate subsystem .....	3.21
Table 3-5	CALibration system .....	3.22
Table 3-6	CONTRol subsystem .....	3.24
Table 3-7	DIAGnostic subsystem .....	3.25
Table 3-8	INPut subsystem .....	3.26
Table 3-9	SENSE subsystem.....	3.28
Table 3-10	STATus subsystem .....	3.38
Table 3-11	SYSTem subsystem .....	3.40
Table 3-12	TEST subsystem .....	3.42
Table 3-13	TRIGger subsystem.....	3.44
Table 3-14	UNIT subsystem.....	3.45
Table 3-15	Synchronization with *OPC, *OPC? and *WAI .....	3.49
Table 3-16	Meaning of the bits used in the status byte .....	3.53
Table 3-17	Meaning of the bits used in the event status register .....	3.54
Table 3-18	Meaning of the bits used in the STATus:OPERation register .....	3.55
Table 3-19	Meaning of the bits used in the STATus:QUESTionable register.....	3.55
Table 3-20	Resetting instrument functions .....	3.58
Table 5-1	Measuring equipment and accessories.....	5.1
Table 5-2	Test report .....	5.9
Table A-1	Interface functions .....	A.2
Table A-2	Universal Commands .....	A.3
Table A-3	Addressed Commands.....	A.3
Table A-4	Control strings or control characters of the RS-232-C interface.....	A.5
Table E-1	Default Settings .....	E.1







Certificate No.: 960292

This is to certify that:

Equipment type	Order No.	Designation
NRT	1080.9506.02/.62	Power Reflection Meter
NRT-B1	1081.0902.02	Interface
NRT-B2	1081.0702.02	Two rear Input
NRT-B3	1081.0502.02	Battery Supply
NRT-Z3	1081.2705.02	RS232 Interface Adapter
NRT-Z4	1120.5005.02	PCMCIA Interface Adapter
NRT-Z43	1081.2905.02/.20	Directional Power Sensor
NRT-Z44	1081.1309.02/.03	Directional Power Sensor

complies with the provisions of the Directive of the Council of the European Union on the approximation of the laws of the Member States

- relating to electrical equipment for use within defined voltage limits  
(73/23/EEC revised by 93/68/EEC)
- relating to electromagnetic compatibility  
(89/336/EEC revised by 91/263/EEC, 92/31/EEC, 93/68/EEC)

Conformity is proven by compliance with the following standards:

EN61010-1 : 1993 + A2 : 1995  
EN50081-1 : 1992  
EN50082-1 : 1992

Affixing the EC conformity mark as from 1996

**ROHDE & SCHWARZ GmbH & Co. KG**  
**Mühldorfstr. 15, D-81671 München**

Munich, 2000-02-04

Central Quality Management FS-QZ / Becker



# 1 Preparation for Use

## 1.1 Front and Rear View (see next two pages)

## 1.2 Putting into Operation



The following instructions should be strictly observed, in particular when putting the instrument into operation the first time, to avoid damage to the instrument and hazards to persons.

### 1.2.1 Unpacking

After unpacking the instrument, check for completeness according to the delivery note and the accessory lists for the individual items.

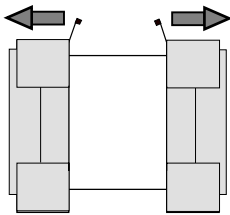

Remove protective covers

Remove the two protective covers from the front and rear of the NRT and carefully check the instrument for any damage. In case of any damage you should immediately inform the responsible transport agent and keep all packing material not to forfeit your claims.

The original packing should also be used for any later transport or shipment of the NRT. You should keep at least the two protective covers for the front and rear of the instrument.

### 1.2.2 Setting Up

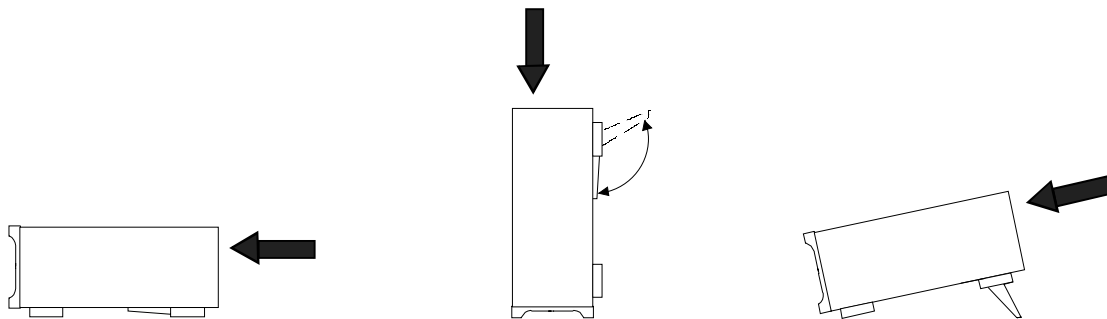

The Power Reflection Meter NRT can be operated in any position. With the two tiltable feet the angle of the instrument can be adjusted.

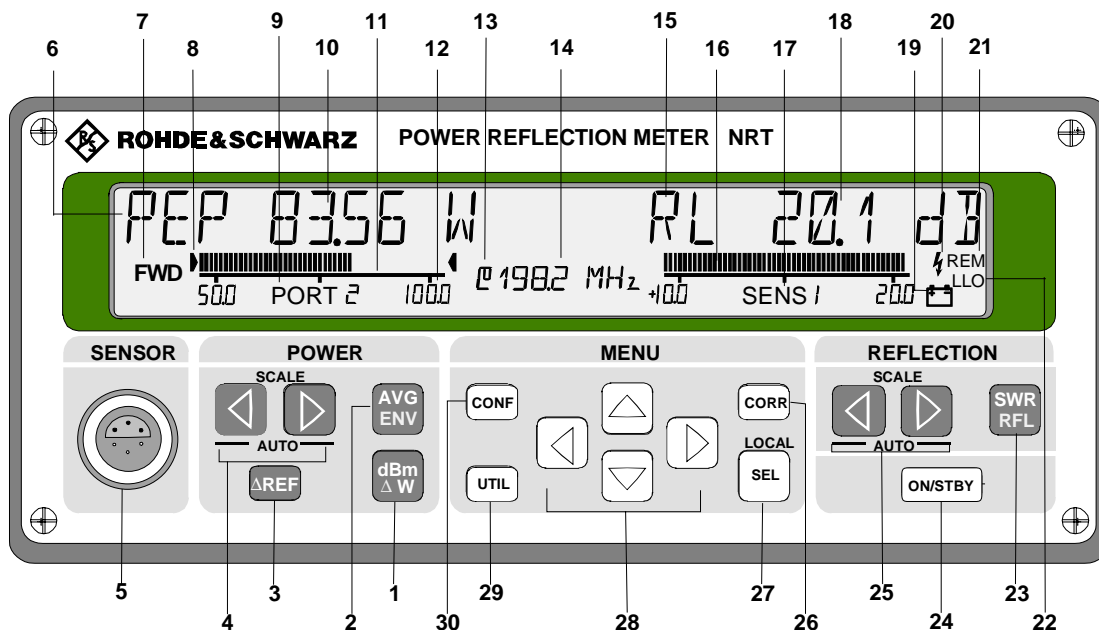

Fig. 1-1 Front view - display

<b>Power measurement</b>		<i>Chapter</i>	<b>Reflection measurement</b>		<i>Chapter</i>
<b>1</b>	Key for selection of unit: W, dBm or relative value (in dB or %)	2.2.2 2.3.9	<b>15</b>	Measured quantity: SWR: voltage standing wave ratio RL: return loss R.CO: reflection coefficient RFR power ratio R/F - reverse power	2.1.4.1 2.3.9
<b>2</b>	Key for selecting AVeraGe power or ENVELOpe parameter	2.2.2 2.3.1	<b>16</b>	Bargraph for reflection measurement	
<b>3</b>	Key for using the current measured value as reference value	2.2.2 2.3.8.1	<b>17</b>	Indication of active sensor connector (SENS 1: front-panel connector)	2.1.7
<b>4</b>	Cursor keys for fixing the scale limits of the bargraph for the power indication	2.2.3	<b>18</b>	Measured reflection with unit	
<b>5</b>	Front-panel connector for power sensor of type NRT-Z (sensor 1)	1.2.7	<b>19</b>	Indication of battery operation. If the battery symbol is blinking, the battery must be recharged	1.4.1 2.5.4
<b>6</b>	Measured quantity: AVG: average power PEP: peak envelope power CF: crest factor AV.BRST: average burst power CCDF: complementary cumulative distribution fcn.	2.3.1	<b>20</b>	Indication of battery charging	1.4.2
<b>7</b>	Power indication: FWD: forward power F-R: absorbed power	2.3.2	<b>21</b>	Indication of remote control of NRT	3.2.1.2
<b>8</b>	Indication that scale limits of power measurement are fixed	2.1.5 2.2.3	<b>22</b>	Indication of keyboard locking (Local Lockout – via IEC/IEEE bus only)	3.2.1.2
<b>9</b>	Indication of sensor connector, to which the measurement result is referred (only with sensors of Type NRT-Z)	2.4.4	<b>23</b>	Key for switchover between standing wave ratio and one of the reflection parameters RL: return loss R.CO: reflection coefficient RFR power ratio R/F - reverse power	2.2.2 2.3.9
<b>10</b>	Measured power with unit		<b>24</b>	ON/STBY key for power up or switching to standby mode	1.2.6 1.2.10
<b>11</b>	Bargraph for power measurement		<b>25</b>	Cursor keys for fixing the scale limits of the bargraph for reflection measurement	2.1.5 2.2.3
<b>12</b>	Scale limits and underrange identification	2.2.3			
<b>13</b>	Indication that an external reference frequency value is used (no meas. value); omitted when the cable loss is displayed at the same time	2.1.6.1 2.4.1 2.5.9			
<b>14</b>	Indication of correction frequency and/or cable losses	2.1.6.1 2.5.9			

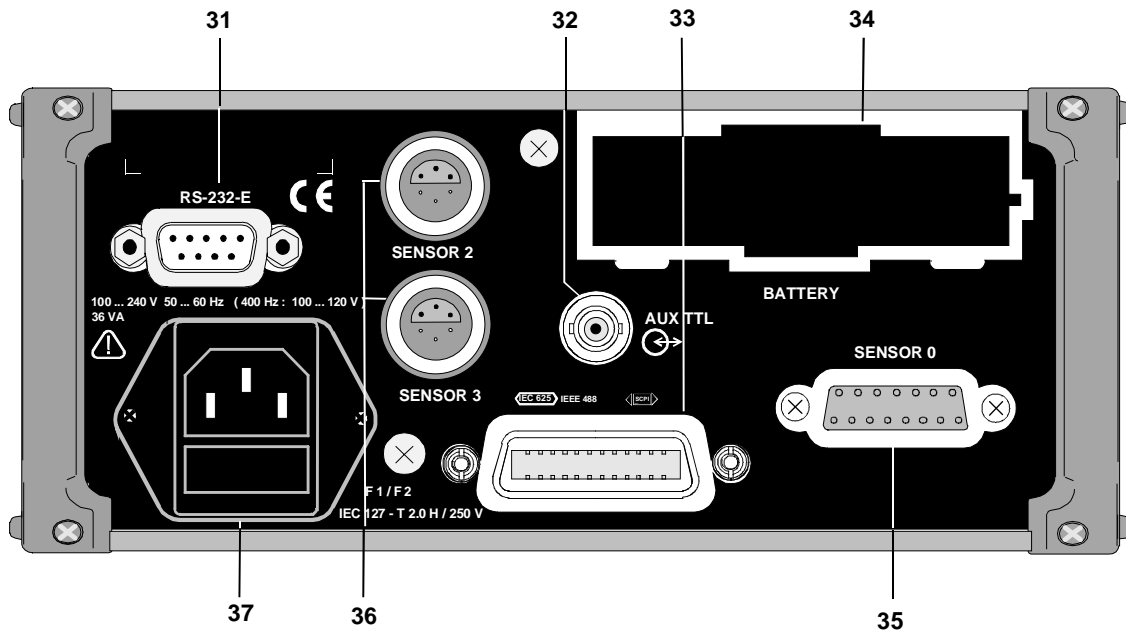

Fig. 1-2 Rear view

**Selection and setting of menus (see Front Panel, previous page)**

		Chapter
<b>26</b>	Key for opening the CORREction menu: improvement of measuring accuracy	2.4
<b>27</b>	SElect key for terminating the entry	2.2.5.2
<b>28</b>	Cursor block for scrolling in the menus, marking of parameters to be set and for numeric entries	2.2.5.2
<b>29</b>	Key for opening the UTILity menu: general settings of the instrument	2.5
<b>30</b>	Key for opening the CONFig menu: setting of measurement parameters that are not available through direct access keys	2.3

**Remote control**

		Chapter
<b>31</b>	RS-232 interface	3.1.2 3.2.2 Anhang A
<b>32</b>	External trigger input or signalling output	3.5.15 2.5.8
<b>33</b>	IEC/IEEE-bus interface	3.1.1 3.2.1 Anhang A

**Sensor connector**

<b>35</b>	Connector for sensor of the NAP-Z type (SENSOR 0)	1.2.7
<b>36</b>	Two connectors (SENSOR 2, 3) for sensors of the NRT-Z type (option NRT-B2)	1.2.7

**Power supply**

<b>34</b>	Ni-MH rechargeable battery for battery operation (Option NRT-B3)	1.4
<b>37</b>	Power connector with fuses	1.2.4 1.2.5

### 1.2.3 Rackmounting

The Adapter ZZA-97 (Order No. 0827.4527.00) allows the NRT to be mounted in 19" racks. The NRT may be accommodated in the left or right part of the rack and together with an other instrument of the same size (9.5" width, 2 height units). Rackmounting is described in the installation instructions for the rack adapter.

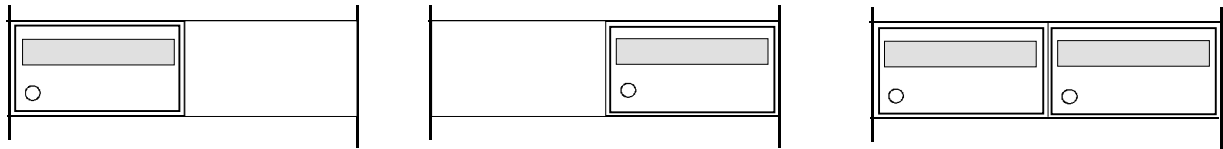

For rackmounting it is recommended to fit the option NRT-B2 (Order No. 1081.0702.02), which provides two rear-panel connectors for sensors of type NRT-Z. Sensors of type NAP-Z are always connected to the rear panel of the NRT.



**An all-pole disconnect facility should be provided for rackmounting, since the NRT has no isolating switch and can only be disconnected from the AC supply by unplugging the power cord.**

### 1.2.4 Connection to AC Supply



**Allow instrument with condensation to dry up before switching it on!  
Observe permissible ambient temperatures -10°C to +55°C!  
Do not cover up air vents!**

The NRT may be connected to a single-phase AC supply with a rated voltage from 100 to 240 V and rated frequency from 50 to 60 Hz. For connection to 400-Hz networks it should be noted that for safety reasons the maximum AC supply voltage is 120 V.

**Note: The NRT automatically sets itself to the local AC supply voltage. There is no need for external switchover or exchanging the fuses.**

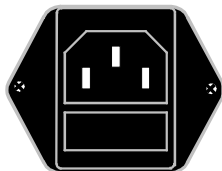

← Power connector  
← Power fuses

Use the power cord supplied with the NRT for connection to the AC supply. Since the NRT is designed in line with protection class I requirements to EN61010 it may only be connected to an earthing-contact type connector. As soon as the connection has been established, the switch-on routine appears on the NRT display.



**Since the NRT has no isolating switch, it can only be disconnected from the AC supply by unplugging the power cord.  
The AC outlet should therefore be easily accessible, the length of the power cord should not exceed 2.5 m!**

### 1.2.5 Power Fuses

The NRT is fully fused by two fuses IEC127-T2.0H/250 V. The fuses are accommodated in the pull-out fuse holder below the power connector. Before replacing the fuses, disconnect the power cord from the NRT. Use a screwdriver to lift the fuse holder below the power connector and pull it out. Use only fuses of the above type. Two spare fuses are supplied with the accessories.

### 1.2.6 Power Up



The NRT is switched on with the ON/STBY key on the front panel. After power up, the version number, date and IEC-bus address should be visible on the display (see Section 1.2.10). The NRT has no special pilot light for signalling the power-up state.

If switching on is not possible, test the connection to the AC supply and eventually exchange the two power fuses (see Section 1.2.5).

Pressing the key twice switches the NRT to the standby mode. In the standby mode, most of the electronics, the display and the power supply of the sensors are switched off. The connection to the AC supply is maintained and can only be interrupted by disconnecting the power cord.

The NRT is automatically switched on - without pressing the ON/STBY key - as soon as AC supply voltage is applied. The NRT can thus centrally be switched on in a rack.

### 1.2.7 Connecting a Sensor to the NRT

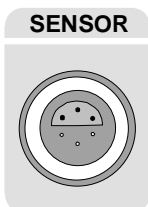

Power measurements with the NRT are possible in conjunction with a sensor of type NRT-Z or NAP-Z. All sensors can be connected or disconnected any time and irrespective of the power-up status of the instrument.

NRT sensors are connected to the *SENSOR* connector on the front panel. If option NRT-B2 is used, they can also be connected to one of the two rear-panel connectors *SENSOR 2* or *SENSOR 3*.

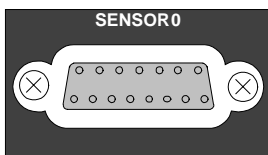

NAP sensors can be connected to the NRT in conjunction with option NRT-B1. A 15-contact connector designated *SENSOR 0* is available on the rear panel.

If several sensors are connected to the NRT simultaneously the active sensor is selected via the *SEL (LOCAL)* key and the vertical cursor keys (see Sections 2.1.7 and 2.2.4).

### 1.2.8 Switching Sensor into RF Circuit

Most of the power sensors for connection to the NRT are for high power ratings. In case of improper connection of the sensor or use of an inappropriate type of sensor considerable power may be set free which may cause damage to the instruments used or even affect the health of the operator. Therefore please observe the following:



**Use suitable sensors! Make sure that power rating and frequency range are appropriate!**

**Switch the sensor into the test circuit only with the RF power switched off!**

**Tighten the RF connector firmly by hand!**

**Non-observance may cause injuries, eg skin burns, damage to the instruments used and premature wear of the RF connector!**

### 1.2.9 EMC Shielding Measures

To avoid electromagnetic interference, the instrument must always be closed when in operation. Use only appropriate, shielded signalling lines and control cables.

### 1.2.10 Function/Power-Up Test

Upon power up the NRT performs a number of automatic checks. If no error messages are displayed during the entire switch-on process, the NRT is ready for operation.

The switch-on process should run as follows (NRT powered from AC supply, at least one sensor connected):



Short beep after approx. 1 s

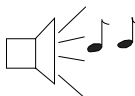

Indication of software version (1.4) with date of completion (January 26th, 1997) and IEC-bus address (12).

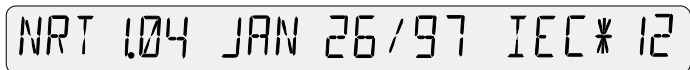

Indication of sensors identified (1 und 2).

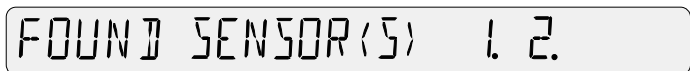

Indication of initialization of sensors.

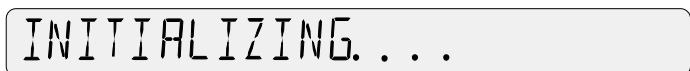

Indication of measurement results (depending on equipment configuration, sensor, RF power).

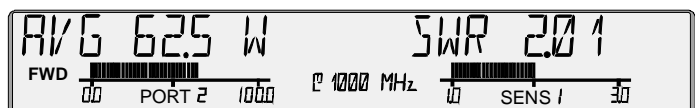



If no error messages are displayed during the entire switch-on process, the NRT is ready for operation.

If *NO SENSOR RESPONSE* is indicated, the NRT has not found a sensor. Check in this case for proper connection of the sensor.

A rectangular LCD display with a black border showing the text "NO SENSOR RESPONSE" in a large, white, monospaced font on a dark background.

If *SENS WARN* is indicated in the small display field in the center the sensor is in an irregular operating mode. For detailed information refer to the *TEST - SENS* parameter in the UTILity menu (see. Section 2.5.8).



Further instructions for troubleshooting can be found in Chapter 4, Maintenance and Troubleshooting, and in Appendix B, Error Messages. If the NRT still cannot be put into operation, please contact the responsible R&S representative.

### 1.3 Installation of Options

The following options are available for the NRT:

Interface for Sensors NAP-Z	NRT-B1	1081.0902.02
Two rear-panel inputs for Sensors NRT-Z	NRT-B2	1081.0702.02
Ni-MH battery and built-in battery charger	NRT-B3	1081.0502.02

The NRT is delivered with the options already installed. If you order the options subsequently, please follow the installation instructions in Section 4.5 of this manual.

## 1.4 Battery Operation (with Option NRT-B3)

### 1.4.1 General

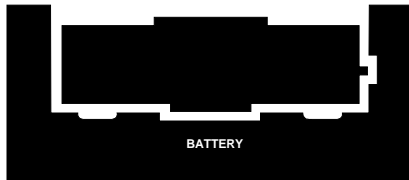

The option NRT-B3 allows the NRT to be operated up to 8 hours without AC supply. The option consists of a Ni-MH battery and a quick charge facility. An empty battery can thus be fully charged within about two hours.



The NRT is battery-powered whenever an AC supply is not available and a charged battery is in the battery compartment. Battery operation is indicated by a symbol on the display.

With AC supply being available, battery powering of the NRT is not possible.

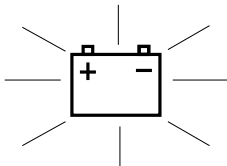

If the battery symbol starts blinking, the battery is discharged and the NRT will be switched off within a few minutes.

### 1.4.2 Charging the Battery

The Ni-MH battery provided with the NRT can be charged automatically; charging may also be started and stopped by the user. Charging is automatically initialized whenever a battery is replaced with the instrument being on or when the NRT is connected to the AC supply after at least 4 hours of battery operation.

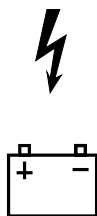

Charging is indicated by the danger arrow and battery symbol. Charging takes about two hours, with battery voltage and temperature being continuously monitored, and is automatically switched off when the battery is fully charged (danger arrow and battery symbol disappear). If required, the NRT can be configured such that it automatically switches off after the battery has been charged (Section 1.4.3). Charging is interrupted if the NRT is switched off via the ON/STBY key.

To avoid damage to the unit, please observe the following:



**Do not charge the battery at ambient temperatures below 0°C or above 45°C!**

**If the battery is very cold (below 0°C), allow it to warm up prior to charging!**

**Immediately unplug the power connector if there are signs of battery overheating!**

Ni-MH batteries reach their full capacity only after 5 to 10 charge cycles. Therefore, the battery of the NRT should be fully discharged and recharged several times on initial start-up. Lifetime is longest if the battery is recharged only when it is entirely empty.

### 1.4.3 Manual Start/Stop of Battery Charging

Charging can be started any time manually or via the remote-control interfaces. It should be carried out whenever the NRT is to be operated without AC supply over a longer period and there is no possibility of recharging the battery during this period. Charging can be manually started via the *UTILity* menu as follows:



Press the menu key



Press the cursor key repeatedly until the charge menu is displayed.

BATTERY CHARGE\* OFF ON



Press the cursor key to shift the underscore to the right. ON is selected and the underscore is blinking.

BATTERY CHARGE\* OFF ON

LOCAL



Press the input key to confirm the setting ON. Charging starts. The NRT returns to the measurement mode.

Charging is automatically completed as soon as the battery is fully charged. It can however be stopped prematurely by selecting *OFF* in the charge menu or by switching off the NRT via the ON/STBY key.

Occasional charging of partly discharged batteries does not cause any damage. Fully charged batteries should however not be recharged repeatedly as this may cause damage in the long run.

It may sometimes be useful that the NRT automatically switches off after charging. This setting is selected via the UTIL menu:



Press menu key.



Press cursor key until the *AFTER CHARGE* menu appears.

AFTER CHARGE\* OFF RUN



Select menu item *OFF*.

AFTER CHARGE\* OFF RUN

LOCAL



Press the entry key to confirm the *OFF* setting. The NRT will then automatically switch off after charging.

**1.4.4 Reducing the Power Consumption**

The power consumption of the NRT is markedly increased by the remote control interfaces, in particular the IEC-bus. Therefore, in the case of battery operation, remote control interfaces not used should be switched off via the UTILity menu:



Press menu key.



Press cursor key repeatedly until the *REMOTE* menu appears. The active state is underscored (here: IEC-bus interface active).



Press cursor key until *OFF* is marked by a blinking underscore.

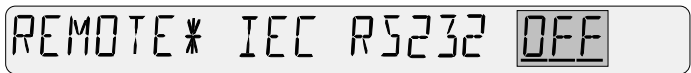

Confirm selection *OFF* by pressing the input key. The NRT returns to the measurement mode.

The selection *OFF* remains stored even after switching off the NRT. Therefore, the interface must be reactivated for later remote control.

### 1.4.5 Preselection of ON Period

To save further power, the NRT can be configured for automatic switch-off after a certain time in battery mode. The NRT is automatically switched off if within a set period (5 min, 20 min or 2 h) neither a key is pressed nor a remote-control command sent. The setting is made in the UTILity menu. In the following example, automatic switch-off is activated after 20 min:



Press the menu key.



Press the cursor key repeatedly until the automatic switch-off menu is displayed.

AUTO.OFF \* NO 5M IN 20M IN 2H



Press the cursor key 2× to shift the underscore to the right. 20MIN is selected and the underscore is blinking.

AUTO.OFF \* NO 5M IN 20M IN 2H



Press input key to confirm the setting 20MIN. The NRT returns to the measuring mode.

Some seconds before switching off the NRT sends a repeated, rhythmical beep signal. If any key is pressed during this time the switching off process is cancelled and the ON period is extended by the selected value.

### 1.4.6 Battery Counter

The NRT contains two counters one of which registers the battery operating time since the last complete charging of the battery. As a fully charged battery allows to operate the NRT for about 8 hours, this gives an estimate of the remaining battery capacity. The battery time is displayed via the UTILity menu.



Press menu key.



Press the cursor key repeatedly until the battery time is displayed.

BATT.TIME \* 5.2 H



To return to the measuring mode, press input key or any key outside the menu field.

The battery counter is automatically reset after each complete charging of the battery (except for manual stop of charging according to Section 1.4.3).

### 1.4.7 Replacing the Battery

In mobile use it may be advisable to take along a charged spare battery to replace the flat one if required. The battery can be replaced without any tools from the rear of the instrument (see Fig. 1-3). To remove the battery, press tightly together the plastic cap and withdraw it with the inserted battery. When inserting the new battery, make sure that the marking **TOP** is pointing upwards. Otherwise it will not be possible to insert the battery fully. The possibility of wrong polarity or short circuit during the battery insertion has been excluded by appropriate design measures.

Spare batteries under the designation NRT-Z1 (Order No. 1081.1209.02) are available from Rohde & Schwarz. The battery comes complete with the plastic cap used as a holder. Please note that batteries ordered from the manufacturer FEDCO (type designation ENERGY+ DR30AA) do not come with the plastic cap. In this case the cap of the old battery has to be used (lift locking tabs to remove it). The cap is not designed for frequent exchanging.

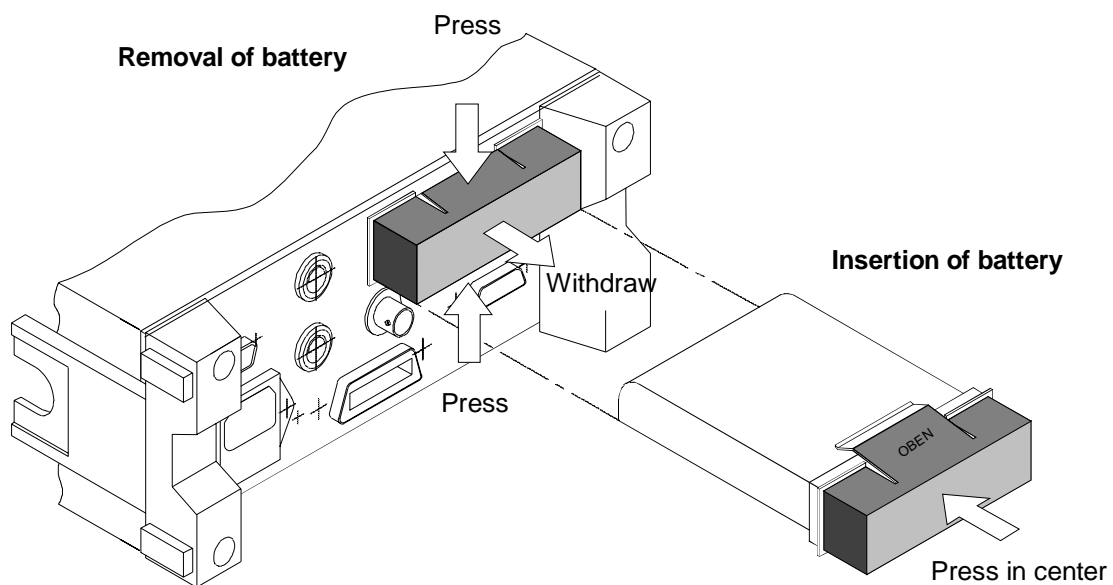

Fig. 1-3 Replacing the battery



**Do not short-circuit the electrical contacts of the battery under any circumstances!**

**Used up batteries should be disposed as hazardous waste!**

**Do not dispose used up batteries should as ordinary waste nor burn them!**

## 2 Manual Operation

### 2.1 Short Introduction

The following sections describe how to operate the NRT by way of a few selected examples. The main functions are described in detail together with the control keys. Where no explanations are given, please refer to Section 2.2, Basic Operating Functions, as well as to the description of the menus starting from Section 2.3.

It is assumed that only one sensor is connected and initialization has been completed successfully. The operation with several sensors is described in Section 2.1.7.

#### 2.1.1 Correct Connection of Sensor

The sensors for the NRT (NRT-Z and NAP-Z) have to be connected between source and load. They measure the power flux in both directions, ie from the source to the load (forward power) and conversely (reverse power). The ratio of forward and reverse power is a measure for the matching of the load which can be expressed as standing wave ratio (SWR), return loss or reflection coefficient.

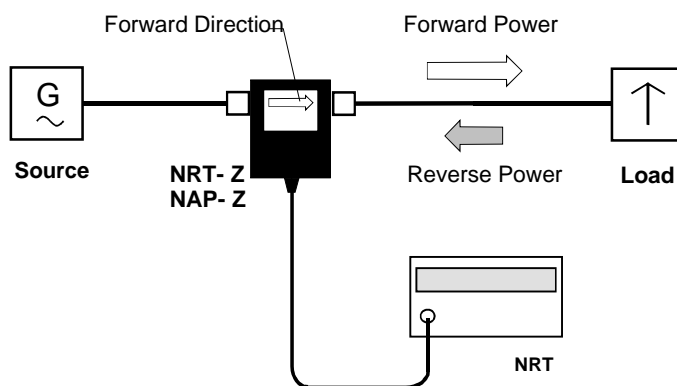

To increase the dynamic range for the reflection measurements, some of the sensors of type NRT-Z are of unsymmetrical design, ie it has been taken into account that the reverse power is usually much smaller than the forward power. These sensors should therefore normally be connected into the test set as specified on the type label.

#### 2.1.2 Default Setup

With a few keystrokes a default setup can be compiled on the NRT which is usually sufficient for many applications (see section 2.5.2).











The setup includes the following measurement functions:

- **Average value (AVG) of forward power (FWD) in W** *(left part of display)*
- **Standing wave ratio (SWR) of load** *(right part of display)*

with the following settings:

- Correction of measured value with default frequency,
- Results referred to load,
- Automatic scaling of bargraph.
- Cable attenuations not taken into account

The default setup is stored in the setup memory under address 0 and can be recalled as described in the following:

	<p>Press this menu key.</p>	
	<p>If <i>SAVE</i> is underscored, use the cursor key to select <i>RECALL</i>.</p>	
<p>LOCAL SEL</p> 	<p>Press input key; the numeric entry is activated, the indicated number starts to blink.</p>	
	<p>Press the cursor keys until 0 is displayed.</p>	
		
<p>LOCAL SEL</p> 	<p>Pressing the input key terminates the numeric entry and sets the NRT to the default setup.</p>	

The display shown here is an example only. The actually indicated values depend on the power and the matching in the test setup and on the sensor used. With an NAP sensor, there is no *PORT 2* indication below the left bargraph and no carrier frequency indication @ 2270 GHz.

### 2.1.3 Measuring the Power

#### 2.1.3.1 Unit Selectable in W or dBm

 The *dBm/Δ/W* key allows selection of the unit *W* or *dBm* for the power indication in the left part of the display. At every third keystroke, the relative difference between the measured power and the stored reference value is indicated in *dB* or *%* (see next section).

The *dBm/Δ/W* key is not effective for the complementary cumulative distribution function (CCDF).

#### 2.1.3.2 Measuring Relative Power Differences

 The *ΔREF* key can be used to store the currently measured power and use it as a reference for a relative display. At the same time, the instrument switches to relative display. Immediately after pressing the key, 0.0 % or 0.0 *dB* should be displayed.

 The *dBm/Δ/W* key can be used to switch any time from the relative to the absolute readout (in *dBm* or *W*) and vice versa.



The CONFig menu allows the relative readout to be defined in dB or %. To change the current setting, proceed as follows:



Press the menu key.



Press the cursor key until the submenu ΔKEY is displayed:



Use these keys to select the desired display unit (in the example shown: %). The underscore is blinking.



Confirm the selected setting with this key. The NRT returns to the measurement mode.

**Note:** Via the CONFig menu (*SPEC - ΔREF* submenu) the stored reference value can be read out and changed.

### 2.1.3.3 Measuring Envelope Parameters (ENV)



The AVG/ENV key can be used to switch between indication of the average power (AVG) and any other parameter characterizing the envelope of the RF signal (ENV). Depending on the type of sensor used, the following parameters can be displayed:

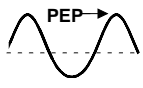

#### Peak envelope power (PEP)

This is the periodically recurring peak value of the carrier power at maximum modulation. The PEP is an important parameter for describing the modulation characteristics of transmitter output stages. The level difference between PEP and AVG may be between 0 dB (CW signal) and some 10 dB (radar bursts).

The PEP function is supported by the sensors NAP-Z7/Z8/Z10/Z11 and NRT-Z43/44. The latter allow selection of the video bandwidth, so that matching to the modulation signal characteristics is possible.

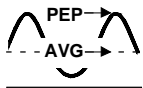

#### Crest Factor (CF)

The crest factor indicates the level difference between the PEP value and the average power in dB. It allows thus to recognize larger modulation distortions. This function is supported by the sensors NRT-Z43/44.

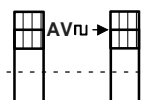

#### Average burst power (AV.BRST)

This term is used for pulsed RF signal to define the average carrier power within the burst. The average burst is equal to the PEP value if the burst is unmodulated and has no overshoots.

The NRT measures the average burst power by multiplying the average power with the ratio of burst period to burst width. The two burst parameters must either be user-defined or the ratio is automatically determined by the NRT. Manual entry of the parameters is possible any time and the sensors NRT-Z43/44 also allow automatic measurement.

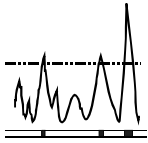

**Complementary cumulative distribution function (CCDF):** This function provides information about the probability of the peak envelope power exceeding a preset threshold. It is suitable eg for assessing the power distribution of spread-spectrum signals (CDMA or similar).

The sensors NRT-Z43/44 provide this function. The video bandwidth can be selected.

The desired ENvelope function can be set via the CONFig menu. For manual setting proceed as follows: press CONF key, select *ENV KEY* submenu and set the function.

## 2.1.4 Measuring the Reflection

### 2.1.4.1 Switching between SWR and another Reflection Parameter



The SWR/RFL key can be used for fast switching between the standing wave ratio (SWR) and another parameter characterizing the matching of the load. The other parameter to be displayed can be selected via the CONFig menu. The following parameters are available:

- Return loss (in dB; header **RL**)
- Ratio between reverse and forward power (0% to 100%; header **RFR**)
- Reflection coefficient (0 to 1; header **R.CO**)
- Reverse power (in W or dBm, according to power indication on left part of display; without header)

Select the desired display as follows: press the CONF key, select the *RFL KEY* submenu and the desired parameter. The return loss is the default setting.

### 2.1.4.2 (De)activating the Acoustic Monitoring

The NRT provides an acoustic alarm signal for continuous checking of the load matching. The alarm is triggered as soon as the SWR exceeds a user-defined threshold. A threshold can be defined in addition to deactivate monitoring at low power levels.

The default values can be set as follows: press the CONF key, select the *SPEC - SWR.ALARM* submenu and the two parameters *MAX.SWR* (for the maximum standing wave ratio) and *THRESHOLD* (for the power threshold).

If *THRESHOLD* is preset to a high value, the acoustic monitoring is deactivated.

## 2.1.5 Fixing the Display Range and Scaling

It is easier to follow rapidly changing measurement results if the mode of display can be fixed. This applies to the decimal point and to the prefix of the unit ( $\mu$ , m, k, M) for the digital readout as well as to the scale limits in analog display mode. The NRT provides two pairs of keys labelled SCALE.

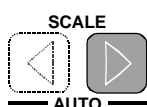

Pressing the right key once fixes the scale limits of the bargraph indicator, the position of the decimal point and the prefix unit of the digital readout. Upon each further keystroke the scale limit is incremented by a fixed amount. If the value becomes too high for it to be indicated in the current setting of the digital display, the decimal point will be shifted and/or the prefix unit changed.

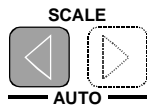

The effect of the left key is in exactly the other direction, ie the scale limit is decremented by a fixed amount.

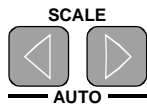

Pressing the two keys simultaneously restores the automatic scaling. It may be necessary to repeat this process since the keys may respond shortly one after the other.

The following illustrations show the effect of fixed and of automatic scaling, using a power reduction from 63.5 W to 0.26 W.

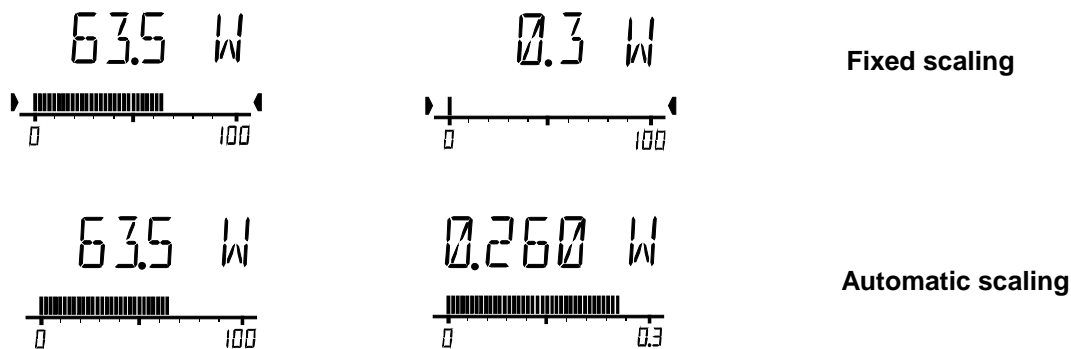

The fixed scaling is shown by the two arrowheads pointing to within the range of the scale limits. Via the *SCALE* submenu in the *CONFig* menu the scale limits for the two bargraphs can be selected completely independently of one another.

## 2.1.6 Enhanced Measurement Accuracy

### 2.1.6.1 Using Frequency Response Correction

Many features of power sensors are frequency-dependent. With a few sensors (NRT-Z, NAP-Z7, NAP-Z8 and NAP-Z42) the individual response has to be taken into account by entering the carrier frequency of the test signal (correction frequency).

If a sensor of type NRT-Z is connected to the NRT, no further action is required after entry of the frequency. The NRT passes the entered frequency on to the sensor which then corrects its measurement results accordingly, using the individual correction factors stored in the data memory of the sensor. The correction frequency can be displayed in the small central readout (see Section 2.5.10), eg in the following form

1000 MHz

To achieve the measurement accuracy specified in the data sheet, the entered frequency has to be accurate to about one percent.

With less stringent requirements on the measurement accuracy, the NRT can also be operated in a default setting, an average frequency value being used for the respective sensor. The measurement uncertainty at the upper and lower end of the frequency range will then be higher.

This is somewhat different with sensors of type NAP-Z. The sensors NAP-Z3 to Z6 and Z9 to Z11 are operated with the default setting, since usually there are no correction values for this type of sensor. The specifications are fully adhered to with this setting. The default frequency is not indicated.

Sensors of type NAP-Z7, NAP-Z8 and NAP-Z42 have a similar response as sensors of type NRT-Z. Since the correction factors are not stored in the sensor but are written down, they have to be first entered into the NRT (see Section 2.4.6). The NRT provides the necessary memory space for up to three different sets of calibration data. The relevant calibration data set has to be selected prior to the frequency entry (see example).

**Note:** When selecting the default setting for an NAP-sensor no frequency value will be indicated. In this case, a calibration factor of 100% for both measurement directions is used.

### Activating the frequency response correction

Based on the default setting, this example is to show how the user-specific frequency response correction is activated by a new frequency value (2,27 GHz). The stored value is overwritten.



Press this menu key, the display shows:

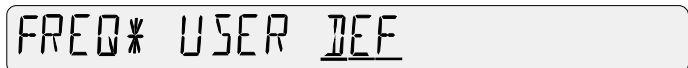

If *USER* is underlined, ie a user-specific setting is already available, skip the next step.



Press the cursor key; the underscore is shifted to the left. *USER* is selected, the underscore starts blinking.

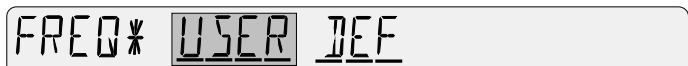

Press this input key; the frequency entered last is displayed.

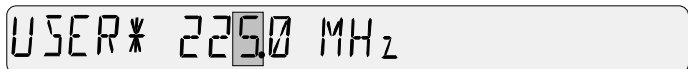

With an NAP sensor the calibration data set selected last is displayed. The setting can either be confirmed with the input key (see example), or another data set can be selected with the cursor keys. The frequency entered last is indicated in this case, too.

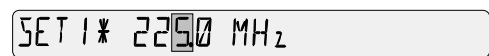
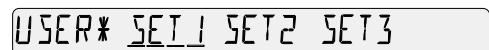

If operation is to be continued with the frequency indicated, press the input key, whereupon the NRT returns to the measurement mode. To change the frequency value, proceed as follows (same for NAP sensor):



Pressing the cursor key 2x increments the selected number by 2.

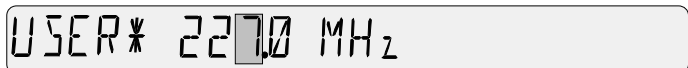

Pressing the cursor key 1x selects the decimal point.

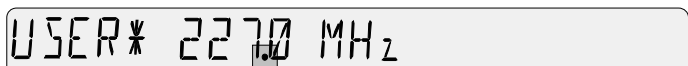

Pressing the cursor key 2x shifts the decimal point two digits to the left.

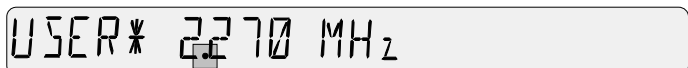



Pressing the cursor key 4x selects the prefix *M* for the unit *Hz*.



Press cursor key to select a higher prefix unit.



Press the input key. The NRT returns to the measurement mode and indicates the entered frequency.



### 2.1.6.2 Zeroing

The NRT provides user-controlled zeroing for all types of sensors. Zeroing enhances the accuracy for measuring low power or low mismatch by reducing the zero error. The zero error is an additive error which may be caused by the electronic circuitry and thermal effects, such as screwing the sensor to a hot RF connector.

To perform zeroing, proceed as follows:

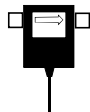

**Switch off RF signal!**



Press this menu key.



Press cursor key; the display shows:



Press this input key; zeroing runs for approx. 4 s.



Thereupon the NRT automatically returns to the measurement mode.

### 2.1.6.3 Increasing the Measurement Accuracy for Modulated Signals

When the power of wide-band modulated signals is measured, the envelope power varies in the rhythm of the modulation. This may cause systematic deviations for all measurement functions (*AVG*, *PEP*, *CF*, *CCDF*). With NRT-Z43/44 sensors, these deviations can be reduced considerably if the properties of the signal can be taken into account during measurement data processing.

To this end, press the *CORR* key, select the *MODULATION* menu and enter the used standard (see also Section 2.4.3). To enable the measurement value correction for the *PEP*, *CF*, and *CCDF* functions, the video bandwidth of the sensor must not be restricted (use setting "*FULL*" in the *VID.BW* submenu for the quoted measurement functions).

### 2.1.6.4 Selecting Forward Power (*FWD*) or Absorbed Power (*F-R*)

The NRT offers the possibility of either the forward power (*FWD*) or the absorbed power (*F-R*) being indicated in the left half of the display. The absorbed power is the difference between the forward and the reverse power, ie it is identical with the effective power transmitted to the load. With good matching, ie SWR better than 1.2 or return loss greater than 20 dB, the difference between forward power and absorbed power is less than one percent. Therefore, distinction between these two quantities is frequently not made.

In case of greater mismatch or more stringent requirements on the measurement accuracy, this simplification is no longer acceptable. Therefore the NRT provides the possibility of indicating the two measured quantities alternatively.

To select the desired quantity proceed as follows: press *CONF* key, select *POWER* submenu and the desired quantity to be displayed.

The table below shows the various settings of the NRT as a function of the measurement task (*MEAS.POS* submenu, see next section, 2.1.6.5).

Quantity to be measured	Load matching	Settings NRT	
		POWER	MEAS.POS
(Effective) power delivered by the source	any	F-R	SOURCE
(Effective) power absorbed by the load		F-R	LOAD
Forward power (at the source)		FWD	SOURCE
Forward power (at the load)		FWD	LOAD
Load matching		FWD / F-R	LOAD
Power of source into 50 $\Omega$	good (SWR <1.2)	FWD	SOURCE

### 2.1.6.5 Reference Plane and Cable Losses

In case of more stringent requirements on the measurement accuracy the fact that the sensor absorbs part of the RF power has to be taken into account. This becomes noticeable in that the signals leaving the sensor are smaller than the input signals, ie it they are attenuated by the insertion loss. Depending on which of the power quantities is to be determined (see table above), the measurement must be made at the source or at the load side. Without this distinction, systematic errors in the magnitude of the insertion loss may occur in the power measurement.

Therefore the NRT offers the possibility of selecting the reference plane. Proceed as follows: press the *CORR* key, select the *MEAS.POS* submenu and select either *LOAD* or *SOURCE*.

As the actual measurement point (output connector of the transmitter or input connector of the antenna) is often not directly accessible, the NRT also requests the entry of a cable loss (*OFFSET*) between the sensor connection and the desired measurement point. If a cable loss is entered, the power and matching values displayed are corrected as if they were measured at the actual (not accessible) measurement point. The cable loss value entered can be shown in the small central readout (section 2.5.10).

To control the reference plane, *PORT 1* or *PORT 2* is indicated below left in the display. The numbers 1 and 2 refer to the connectors of the sensor marked accordingly.

### 2.1.7 Measurement with Several Sensors

The NRT allows simultaneous connection of up to three different sensors of type NRT-Z (connectors 1 to 3) and one NAP sensor. Each sensor is assigned a measurement channel which can be set as desired by the user. The results of the active channel are displayed. The active channel is indicated by **SENS...** below the righthand bargraph.

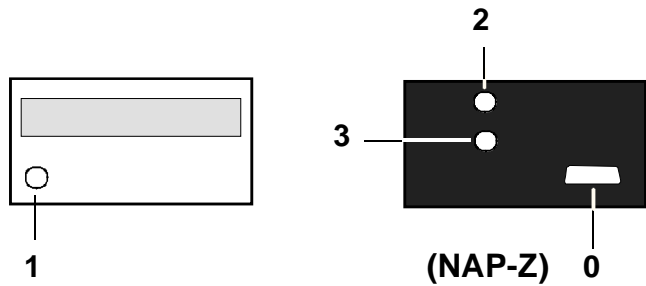

Switchover to another measurement channel is possible any time:

<p>LOCAL SEL</p>	<p>Press input key. The number of the active channel starts blinking and can be changed.</p>	
<p>▲ ▼</p>	<p>Use these keys to select the measurement channel...</p>	
<p>LOCAL SEL</p>	<p>...and confirm the setting with the input key. The NRT is switched to the new measurement channel.</p>	

Measurement is started immediately after switchover. There are no waiting times since all sensors connected to the NRT are permanently powered.

## 2.2 Basic Operating Functions

The NRT basic unit allows a variety of sensors to be adapted to diverse measurement tasks. A large number of settings can be made to cover a wide range of applications.

To make operation as straightforward as possible, all these settings are menu-controlled via softkeys. The main functions are however directly accessible via hotkeys.

The basic operating controls and philosophy are described in the following.

### 2.2.1 Front-Panel Keys

The NRT basic unit has four types of keys (Fig. 2-1):

#### Cursor keys

keys for switching within a selected menu (MENU keypad 2.2.4). The vertical cursor keys are for scrolling through the individual menu items up and down. The horizontal cursors are for switching within the menu item. Cursor keys also allow entry of numeric values (Section 2.2.4.2).

**Function key**  
See below left

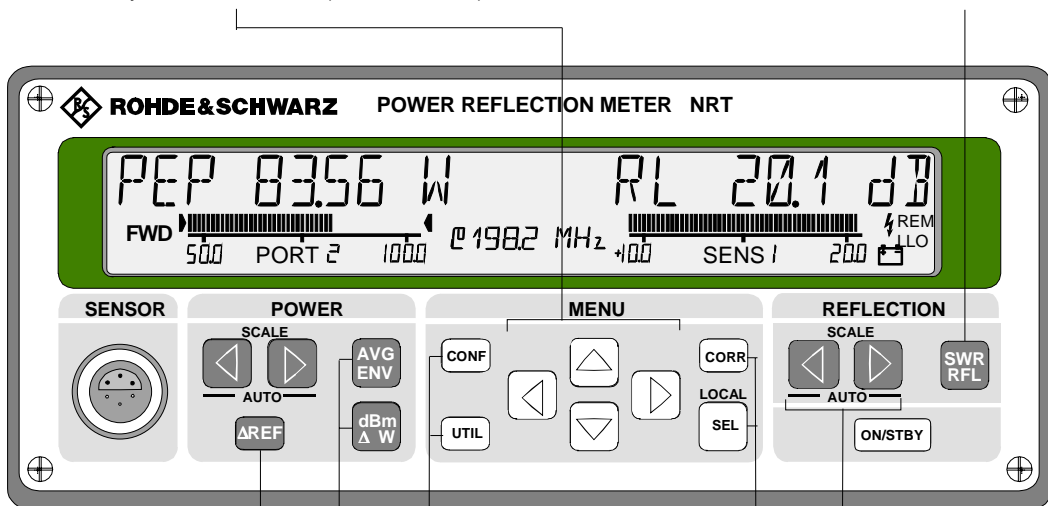

#### Function keys

The main measurement functions are directly accessible via function keys (see Section 2.2.2).

#### Menu keys

The three menu keys activate the associated menus:

- "CONFig", meas. settings, 2.3
- "CORRection", improved meas. settings, 2.4
- "UTILity", Miscellaneous, 2.5.

SEL(LOCAL) is an input key for the menus. general structuring and operation of the menus is described in Section 2.2.4.

#### Scaling keys

The scaling in the POWER and REFLECTION keypad are for changing the scaling of the associated bargraphs (Section 2.2.3).

Fig. 2-1 Front-panel keys



## 2.2.2 Operation via Function Keys



The *AVG/ENV* key is for switching between measurement of the average power (*AVG*) and a configurable measurement function, the envelope parameter (*ENV*). See Section 2.3.1.

IEC/IEEE command: Example: setting the average function:

```
:SENSe<n>:FUNction:OFF "....."
```

The current measurement function must be deactivated before the average function can be switched on.

```
:SENSe<n>:FUNction[:ON]
"POWer:FORWard:AVERAge"
```



The *ΔREF* key accepts the currently indicated measured value as reference value. This measured value can be checked in the *CONFig* menu under the item *SPEC - ΔREF*, see Section 2.3.8.1.

IEC/IEEE command: :SENSe<n>:DATA?  
<value> = response  
:SENSe<n>:POWer:REFEreNce <value>



The *dBm/ΔW* key selects the unit relevant for all power indications.

The key allows selection of *W*, *dBm* or a configurable relative unit, see Section 2.3.9.

IEC/IEEE command: Example: selection of *W*:

```
:UNIT<n>:POWer:RELative:STATe OFF
:UNIT<n>:POWer W
```



The *SWR/RFL* key toggles between the possible reflection parameters.

The key allows selection of the standing wave ratio *SWR* or of a configurable display function, see Section 2.3.10.

IEC/IEEE command: Example: selection of *SWR*

```
:SENSe<n>:FUNction[:ON] "POWer:S11"
:UNIT<n>:POWer:REFlection SWR
```

### 2.2.3 Scaling of Bargraphs and Underrange Identification

In the measurement mode, the bargraphs for power and reflection indication appear in the left and right half of the display. With the associated cursor keys of the *POWER* and *REFLECTION* keypads, the scale range can be adapted.

#### Automatic scaling

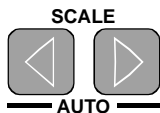

Simultaneous actuation of the two cursor keys switches the bargraph from FIXED mode to AUTO mode. The bargraph scaling is then automatically adapted to the measured value (autoscaling).

IEC/IEEE command: `:SENSE<n>:POWer[:POWer]:RANGe:AUTO ON`

AUTO-Mode



AUTO-Mode  
(Underrange)



If the forward power is too small to measure power or reflection, the NRT displays the underrange identification **uUu** instead of the right-hand scale end value in the left-hand bargraph. The underrange identification disappears in the FIXED mode:

#### Manual adjustment of scale range

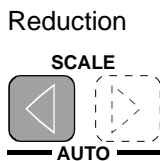

Actuating these keys in

AUTO mode: Range is frozen, instrument switches from AUTO to FIXED mode.

FIXED mode: Depending on cursor key used, range is reduced or increased.

Watt: ..., (0 to 3), (0 to 10), (0 to 30), ..

dB / dBm: ..., (0 to 10), (10 to 20), (20 to 30), ..

%: ..., (-10 to 10), (-30 to 30), (-100 to 100)

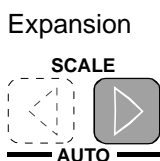

IEC/IEEE command: `:SENSE<n>:POWer[:POWer]:RANGe:AUTO OFF`

No direct response on IEC/IEEE bus since the limits have to be stated explicitly.

`:SENSE<n>:POWer[:POWer]:RANGe:LOWer -10`

`:SENSE<n>:POWer[:POWer]:RANGe:UPPer 100`

FIXED-Mode



The scaling of the bargraphs has no unit. If another unit is selected for the measured value, the scaling is not converted. In FIXED mode, the scale limits of the bargraphs may have any values, they can explicitly be entered in the CONFIG menu (Section 2.3.5).

**Note:** For range monitoring (Section 2.5.9) the associated bargraph always remains in FIXED mode and cannot be switched to AUTO mode.

### 2.2.4 Selection of the Active Sensor



If several sensors are connected to the NRT simultaneously, it is always possible to switch from one active sensor to another by pressing the SEL (LOCAL) key and selecting the desired sensor connection by means of the vertical cursor keys (indication **SENS...** in the bottom right of the display). For details refer to Section 2.1.7.

## 2.2.5 Menu Operation

The NRT basic unit provides a large variety of settings. Parameters that are not frequently changed are accessible via three menus. Each menu has its own key:

<b>CONFig menu</b>	Configuration of measurement function and indication	<b>CONF</b> key
<b>CORRection menu</b>	Functions for improving the measurement accuracy	<b>CORR</b> key
<b>UTILity menu</b>	Miscellaneous functions (interfaces, battery operation, setup settings, battery time counter, tests)	<b>UTIL</b> key

**Switching on the menu** To activate a menu, press the relevant menu key.

**Scrolling in menu** Each menu consists of several menu items which can be scrolled up and down with the vertical cursor keys  and . Only those menu items are visible which are supported by the active sensor. For selection of the sensor see Section 2.1.7.

Each menu item is characterized by a name describing its function, eg "RESOL" for resolution.

**Switching off** ➤ To return to the measured value indication, press any key in the POWER or REFLECTION keypad.



After changing a menu item, the NRT automatically returns to the measuring mode as soon as the entry is terminated by pressing the *SEL(LOCAL)* input key.

### 2.2.5.1 Types of Menu Parameters

According to their function and operation, the menu parameters can be subdivided into three groups:

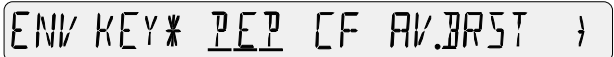
#### Selection parameters



Selection parameters allow setting of one of several states of a menu, eg measurement of the peak envelope power (PEP) within the *ENV KEY* menu item. The total choice of states is shown in the display. If there is not sufficient space, arrows at the right or left end of the menu line indicate that there are more settings available. The currently set state is marked by the setting marker (selected state is underlined). Selection parameters can be edited without further entries. The horizontal keys  and  in the menu field can be used to select another state which is marked by a blinking underscore (selection marker).

With the <sup>LOCAL</sup>  
 key the selected state is accepted and set as current state. The NRT returns to the measuring mode, opens a submenu with further selection parameters or requests the entry of a numeric parameter.

Function parameters

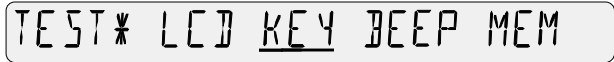

Function parameters allow certain functions to be carried out, eg testing of display, keys, memory and the status indication for the active sensor. The function is selected in the same way as with a selection parameter. The NRT either returns to the measuring mode by itself, or the function must be terminated by a keystroke.

Numeric parameters

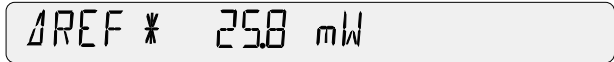

The numeric parameters include test frequency, reference value, SWR alarm limit, etc. They can be assigned any values by the user. The numeric entry is described in detail in the following Section 2.2.5.2.

After termination of the numeric entry, further settings can be made within the menu. An exception are the numeric parameters in submenus since after their valid entry the next higher menu is activated.



2.2.5.2 Numeric Entries

Editable characters

Unless there are restrictions for an individual numeric parameter, it is possible to edit the sign, decimal point, prefix, unit and all numeric digits. The immediately editable digit blinks (highlighted grey in the example shown).





Activating individual digit positions

With the aid of the horizontal cursor keys  and  in the menu field the cursor can be set to any significant digit of the number. This applies also to the sign, decimal point, prefix and unit.



Editing individual digit positions

The vertical cursor keys  and  in the menu field are for changing the digit incrementally.



- Blinking digits are incremented or decremented. A correct carry to the neighbouring digits is made, if 9 is overranged or 0 underranged.
- If the blinking decimal point is edited, it is shifted to the right or left and divides or multiplies the value by ten.
- Editing of a blinking prefix switches to the next higher prefix, eg from k to M, ie the value is multiplied or divided by 1000.
- The blinking sign can be changed from “+” to “-” and vice versa.
- If the unit is blinking, it can also be changed, eg from W to dBm.

**Terminating the entry** ➤ Terminate the entry of the numeric value with the LOCAL  
SEL key.

After a correct entry, the editor is deactivated. In the case of a faulty entry the editor remains active and the previous value is indicated again in the editing field. An acoustic message indicates that the entry is refused.

+ 125. mW

Any key except the keys in the menu field can be used to invalidate the numeric entry and abort editing.

### 2.2.5.3 Menus and Notation

In the following sections all menu commands implemented in the NRT are described in detail. Each of the three main menus is dealt with in a separate section. A brief description and a graphical menu overview is given at the beginning of each section.

A detailed description of each menu item follows next:

- graphical display of the menu item showing its position in the menu,
- description of the parameter,
- data of the parameter.

#### a) Selection/function parameters

	Description of selections	Availability of selection: Always (present) Sensor (sensor-dependent)
<b>Selection 1</b>	Description 1	Availability 1
<b>Selection 2</b>	Description 2	....
<b>Selection 3</b>	....	....

Default setting (preset, see Annex E)  
IEC/IEEE command.

**Note:** IF numeric suffixes are used, they are defined as follows:

<b>&lt;n&gt; = 0,1,2,3</b>	<b>sensor connector,</b>
<b>&lt;m&gt; = 1,2,3</b>	<b>calibration data set.</b>

#### b) Numeric parameters

are defined by stating the

- range,
- unit,
- resolution,
- preset.

Examples for remote control settings are given for all menu items.



All submenus of a menu are dealt with in the same section. The same notation as for the main menu is used. In each submenu display its source is indicated on the left and thus the position in the menu, eg:

CORR - FREQ - USER

USER\* 1200 GHz

## 2.3 CONFig Menu

To ensure clear and straightforward operation of the instrument, only the main settings are available by direct access keys.

Other settings relevant for the measurement task are accessible via the *CONFig* menu. This includes the configuration of the parameters ENV,  $\Delta$ , and RFL via the direct access keys ,  and . Settings for improving the measurement accuracy are collected in the *CORREction* menu.

- Call up the menu with the  key.

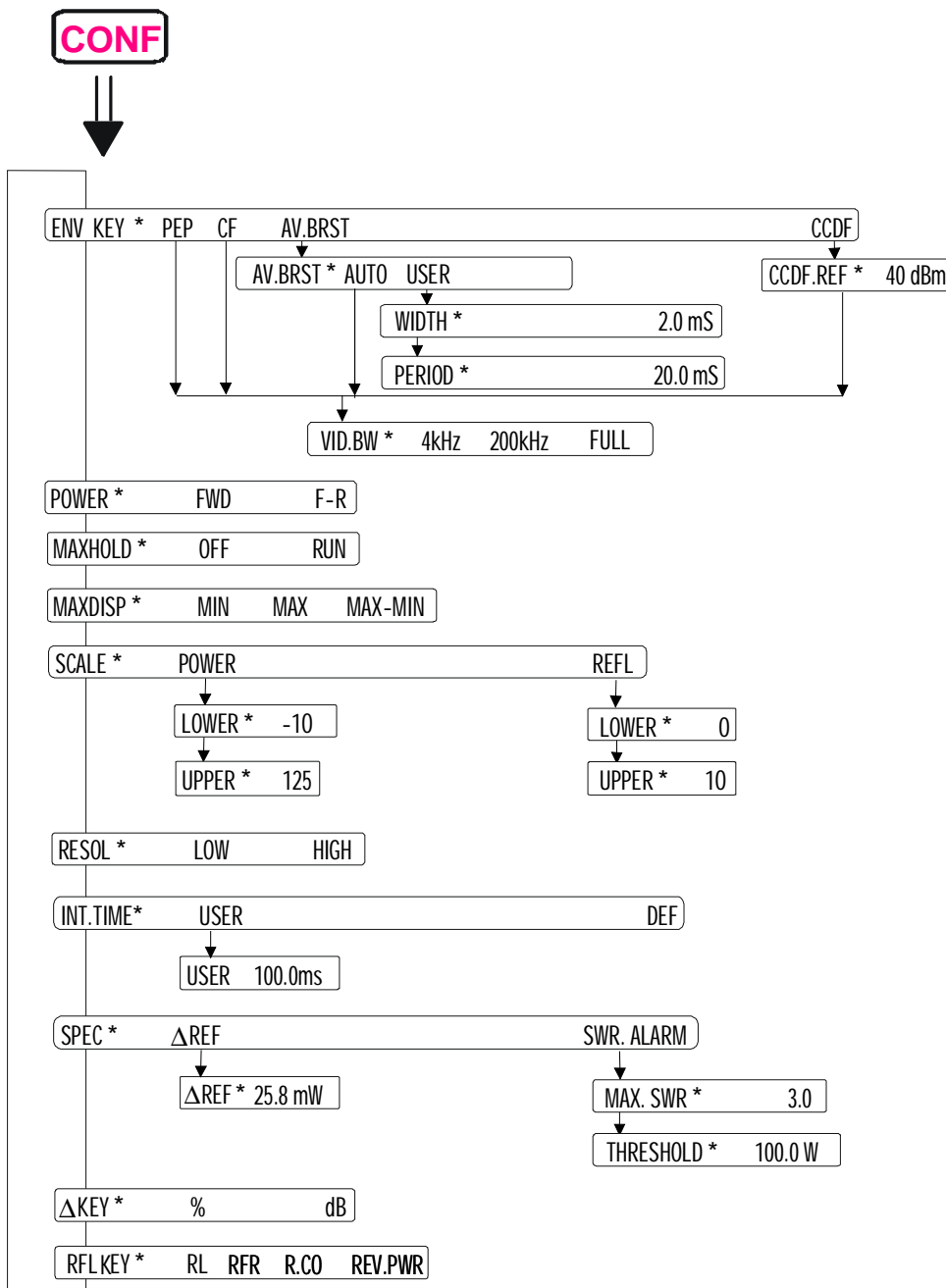

Fig. 2-2 CONFig menu

### 2.3.1 ENV KEY (Selection of Envelope Parameters)

Usually the sensors connected are able to perform more than one measurement function. The most important function of every sensor is the measurement of the average power (AVG). Other power parameters (examples see Fig. 2-3) can be selected in the ENV KEY menu. They vary according to the sensor used.

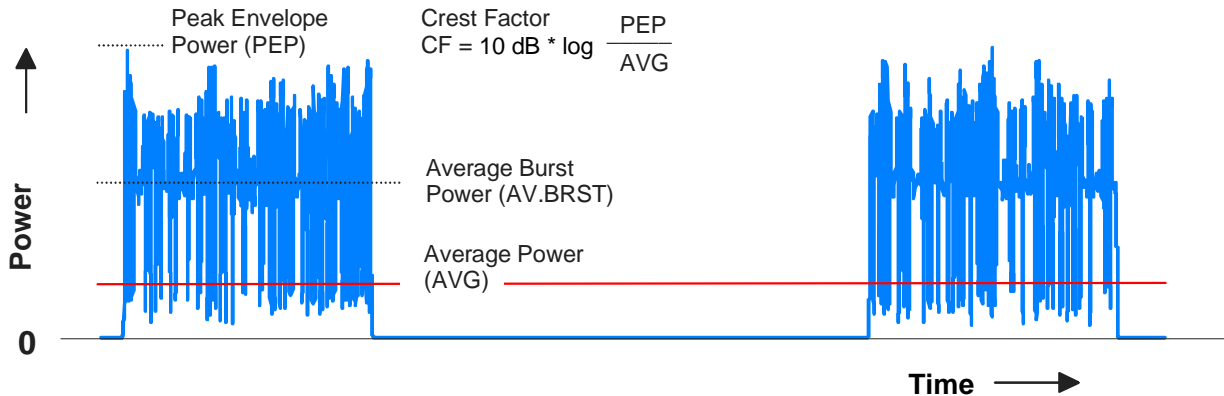

Fig. 2-3 Envelope parameters with burst signal used as an example

The AVG  
ENV key switches between the standard function AVG (average power measurement) and measurement of an envelope parameter ENV. There is a choice between peak envelope power (PEP), average power (AV.BRST), crest factor (CF) and cumulative distribution function (CCDF).

CONFig - ENV KEY:

```
ENV KEY * PEP CF AV.BRST CCDF
```

Only the envelope parameters which can be measured by the connected sensor are indicated.

Selection	Description	Available
PEP	<p><u>P</u>ea<u>k</u> <u>E</u>n<u>v</u>elo<u>p</u>e <u>P</u>owe<u>r</u></p> <p>... is the peak power of an amplitude-modulated signal. Depending on the selected video bandwidth, this function also allows detection of short-time overshoots at the beginning of a burst.</p> <p>The video bandwidth must be specified in a submenu.</p>	Sensor
CF	<p><u>C</u>re<u>s</u>t <u>F</u>ac<u>t</u>or</p> <p>... designates the level difference between the PEP and the average power in dB and thus makes it possible to recognize quickly larger modulation distortions. As for PEP, the video bandwidth must be specified in a submenu.</p>	Sensor

<b>AV.BRST</b>	<u>A</u> verage <u>B</u> urst ... designates the average power <b>within</b> a burst. It is derived by the NRT from the average power and the duty cycle. In a submenu it must be defined whether the duty cycle is to be determined automatically or be derived from the values entered for burst duration and period.	Sensor
<b>CCDF</b>	<u>C</u> omplementary <u>C</u> umulative <u>D</u> istribution <u>F</u> unction ... provides information about the probability of the measured values to lie above a specified threshold.	Sensor

Preset: AV.BRST  
IEC/IEEE command: :SENSe<n>:FUNctIon[:ON] <Measurement Function>

### 2.3.1.1 Measurement of Peak Envelope Power

For measuring the peak envelope power, the video bandwidth used for measuring the detected RF signal has to be specified. The set bandwidths are sensor-dependent and indicated in the menu in plain text as soon as the setting *PEP* is confirmed in the calling menu. The bandwidths shown in the figure below – 4 kHz, 200 kHz, and "FULL" – can be set with sensors NRT-Z43/44. "FULL" means that the maximum bandwidth of the sensor, i.e. approx. 4 MHz, is used.

CONFig - ENV KEY - PEP -  
VID.BW:

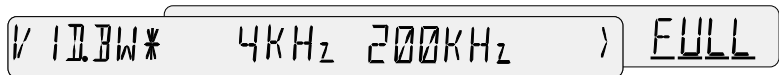

The video bandwidth set in this menu overwrites the settings made in the menus *CF*, *AV.BRST - AUTO* and *CCDF*.

IEC/IEEE command: :SENSe<n>:FUNctIon[:ON] "POWer:FORWard:PEP"  
:SENSe<n>:BANDwidth:VIDeo:FNUMBER <f>  
<f>: see Table 2-1, the preset value depends on the sensor used.

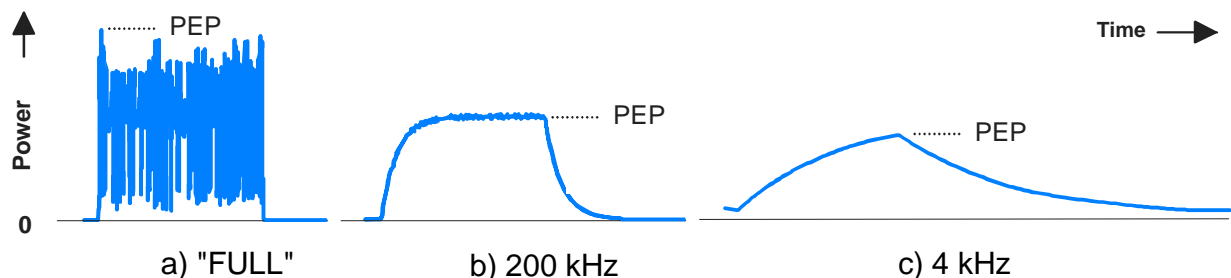

Fig. 2-4 Effect of video bandwidth on indicated peak envelope power

The video bandwidth should be selected as narrow as possible for the measurement task at hand, since in this way the noise superimposed on the rectified signal can be kept low. Low noise allows the measurement of smaller peak envelope powers and causes less variations in indication. Reducing the bandwidth too much, however, may lead to an unwanted distortion of the envelope, see Fig. 2-4.



The table below shows the bandwidths to be set for some common waveforms.

**Table 2-1 Setting the video bandwidths for the PEP, CF, and CCDF measurement functions**

Waveform		Video bandwidth NRT (f)* NRT-Z43/44	
AM	mod. frequency ≤ 1 kHz	4 kHz (0)	
AM	mod. frequency ≤ 50 kHz	200 kHz (1)	
CW burst	burst width ≥ 150 μs	4 kHz (0)	
CW burst	burst width ≥ 3 μs	200 kHz (1)	
CW burst	burst width ≥ 200 ns	FULL (2)	
π/4 DQPSK	symbol rate ≤ 24 k/s	200 kHz (1)	
π/4 DQPSK	symbol rate ≤ 200 k/s	FULL (2)	
CDMA/W-CDMA	chip rate ≤ 8.2 M/s	FULL (2) **	
DAB/DVB-T	-----	FULL (2) **	

\*) f: Index for setting the band width via IEC-bus with the command  
:SENSe<n>:BANDwidth:VIDeo:FNUMber <f>

\*\*\*) To increase the accuracy of spread spectrum signal measurements, the name of the used standard should be reported to the NRT; see Section 2.4.3.

### 2.3.1.2 Crest Factor

The crest factor CF is the level difference between the PEP value and the average power in dB:

$$CF = 10 \text{ dB} \times \log \frac{PEP}{AVG}$$

The crest factor provides information about the dynamic range of transmitters, eg with CDMA signals, for which values up to 10 dB are possible. This measurement is only possible with sensors of type NRT-Z and requires selection of a suitable video bandwidth. The available bandwidths are sensor-dependent and indicated in the menu in plain text as soon as the CF setting has been acknowledged in the next higher menu. The bandwidths shown in the figure below – 4 kHz, 200 kHz, and "FULL" – can be set with sensors NRT-Z43/44. "FULL" means that the maximum bandwidth of the sensor, i.e. approx. 4 MHz, is used.

CONFig - ENV KEY - CF -  
VID.BW:

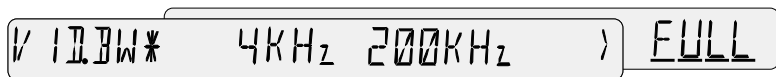

The video bandwidth set in this menu overwrites the settings made in the menus CF, AV.BRST - AUTO and CCDF.

The video bandwidth should be selected as narrow as possible for the measurement task at hand, since in this way the noise superimposed on the rectified signal can be kept low. Low noise causes less variations in indication and allows measurement of the crest factor at low power. Reducing the bandwidth too much, however, may lead to an unwanted distortion of the envelope, see Fig. 2-4. Table 2-1 shows the appropriate setting for some waveforms.

IEC/IEEE command: :SENSe<n>:FUNCTion[:ON] "POWer:CFACtor"  
:SENSe<n>:BANDwidth:VIDeo:FNUMber <f>  
<f>: see Table 2-1, the preset value depends on the sensor used.

### 2.3.1.3 Average Burst Power

In radiocommunications (TDMA) and radar, etc, the RF is radiated in the form of bursts. In addition to the peak envelope power, it is also of interest to measure the average power during the burst, especially with a modulated envelope (with an unmodulated envelope the two parameters are equal). The average burst power is a measure of the output signal strength hence closely linked to the coverage that can be achieved.

The NRT provides two measurement modes, but the AUTO mode is not supported by all sensors:

CONFig - ENV KEY -  
AV.BRST:

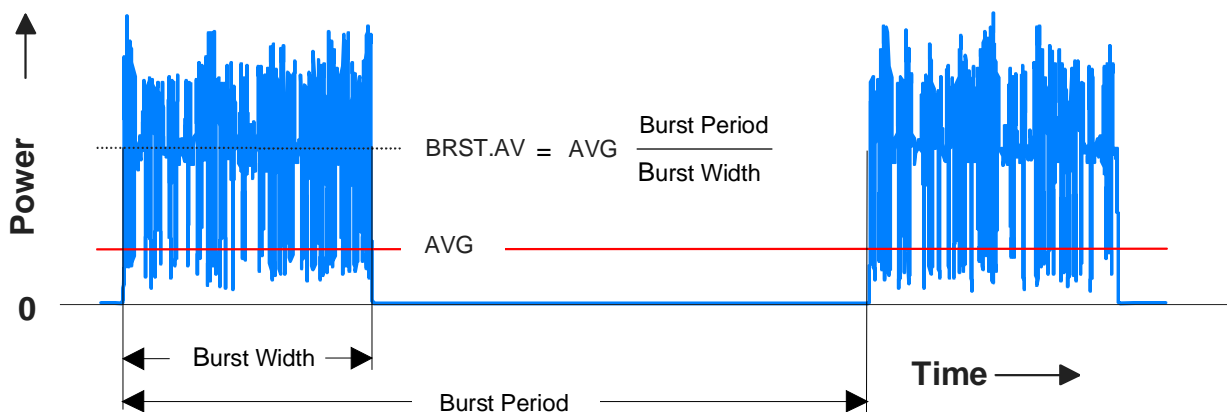

Fig. 2-5 Average burst power

In both modes, the average burst power is calculated by the NRT from the average power and the duty cycle (Fig. 2-5). It is equal to the amplitude of a squarewave pulse sequence having the same average power which is contained within the PEP characteristic. The duty cycle may either be entered in the form of known values (*USER*) or automatically determined by the sensor (*AUTO*).

Selection	Description	Available
<b>AUTO</b>	<p>If provided with this function, the sensor automatically measures the average burst power.</p> <p>This applies also to multiple bursts and to duty cycles variable in time. To ensure proper operation of the automatic function, the video bandwidth has to be defined in a sub-menu.</p> <p>If the limit values defined in the specifications for the power or duty cycle are underranged, the NRT displays "---" instead of a measured value.</p>	Sensor
<b>USER</b>	<p>The burst characteristic must be specified by defining the burst period and burst width.</p>	Always

Preset: USER  
IEC\IEEE command: :SENSe<n>:BURSt:MODE AUTO | USER

### Automatic Measurement (AUTO)

For automatic measurement of the average burst power the video bandwidth (VID.BW) for the rectified signal must be defined. The bandwidths available are sensor-dependent and are displayed in plain text in the menu as soon as the setting AV.BRST is confirmed in the calling menu. The bandwidths shown in the figure below – 4 kHz, 200 kHz, and "FULL" – can be set with sensors NRT-Z43/44. "FULL" means that the maximum bandwidth of the sensor, i.e. approx. 4 MHz, is used.

CONFig - ENV KEY -

AV.BRST - AUTO- VID.BW:

W ID BW\* 4KHz 200KHz ) FULL

The bandwidth should be selected as narrow as possible, observing the limits specified for CW bursts in Table 2-1. The narrow video bandwidth is required to free the rectified signal from the superimposed modulation, so that only a slightly modulated squarewave pulse sequence is obtained. The highest measurement accuracy is achieved with duty cycles above 10%. Duty cycles below 1% should be avoided.

The video bandwidth set in this menu overwrites the settings made in the menus PEP, CF and CCDF.

IEC/IEEE command:

```
:SENSe<n>:FUNctIon[:ON] "POWer:FORWard:AVERAge:BURSt "
:SENSe<n>:BURSt:MODE AUTO
:SENSe<n>:BANDwidth:VIDeo:FNUMBER <f>
<f>: see Table 2-1, the preset value depends on the sensor used.
```

### Measurement with user-defined parameters (USER)

If an automatic measurement of the average burst power is not possible (power or duty cycle too small), the burst parameters must be entered manually in the USER submenu.

After selecting the USER submenu the entry of first the burst width and then the burst period is requested. The selected values must be confirmed with the SEL(LOCAL) key.

#### b) Entry of burst width:

CONFig - ENV KEY -

AV.BRST - USER - WIDTH:

W ID TH\* 100 mS

Unit:

seconds (S)

Preset:

depends on the sensor used

IEC/IEEE command:

```
:SENSe<n>:FUNctIon[:ON] "POWer:FORWard:AVERAge:BURSt "
:SENSe<n>:BURSt:MODE USER
:SENSe<n>: BURSt:WIDTh 10 ms
```

#### b) Entry of burst period:

CONFig - ENV KEY -

AV.BRST - USER - PERIOD:

PER ID\* 40 mS

Unit:

seconds (S)

Preset:

depends on the sensor used

IEC/IEEE command:

```
as for the burst width but:
:SENSe<n>: BURSt:PERIoD 40 ms
```

### 2.3.1.4 Cumulative Distribution Function

The *CCDF* function provides information on the amplitude distribution of the envelope, ie on the probability of the actual value of the envelope power lying above a preset threshold (*CCDF.REF*). The probability in % is indicated together with the threshold value.

The *CCDF* function can only be used to determine the forward power! If the power indication is set to "F-R" (absorbed power, see Section 2.3.2), automatic switchover to *FWD* (forward power) is made when *CCDF* is selected.



After selecting the *CCDF* parameter the entry of first the threshold and then the video bandwidth is requested.

#### a) Entry of the CCDF Threshold

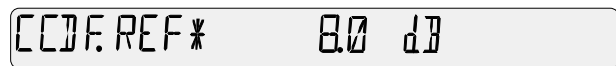
CONFig - ENV KEY - CCDF -  
CCDF.REF:



Unit: W, dBm/dB  
 Preset: depends on the sensor used  
 IEC/IEEE command: :SENSe<n>:FUNctIon[:ON]"POWER:FORWARD:CCDFunction"  
 :SENSe<n>:POWER:CCDFunction:REFERENCE 8.0 dB

The threshold can be entered either as an absolute value (in W or dBm) or in dB, referred to the stored reference value. The unit is switched with the cursor keys  and  at the associated digit.

#### b) Selecting the video bandwidth:

CONFig - ENV KEY - CCDF -  
VID.BW:

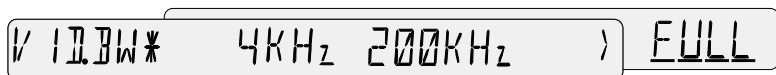

The selected video bandwidth should be at least as large as the bandwidth of the demodulated signal to avoid the loss of any details of the envelope. As a rule of thumb, the demodulated signal should have approximately the same bandwidth as the RF signal. The bandwidths shown in the figure above – 4 kHz, 200 kHz, and "FULL" – can be set with sensors NRT-Z43/44. "FULL" means that the maximum bandwidth of the sensor, i.e. approx. 4 MHz, is used.

To ensure a wide dynamic range, the video bandwidth should be set to the smallest possible value where several settings are possible. Table 2-1 shows the appropriate settings for a variety of waveforms.

The video bandwidth set in this menu overwrites the bandwidth settings made in the menus *PEP*, *CF* and *AV.BRST*.

IEC/IEEE command: :SENSe<n>:BANDwidth:VIDeo:FNUMBER <f>  
 <f>: see Table 2-1, the preset value depends on the sensor used.

### 2.3.2 POWER (Configuration of Power Display)

With the CONFig - POWER menu either the forward power (FWD) or the net transmitted power (forward power - reverse power, F-R) can be displayed. In case of a load with good matching, this makes little difference.

CONFig - POWER:

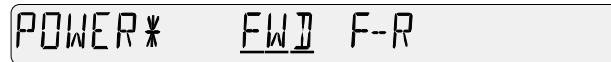

Selection	Description	Available
FWD	Indication of forward power in the left half of the display. The symbol <b>FWD</b> appears in the lower part of the display.	Always
F-R	Indication of the difference between forward and reverse power in the left half of the display. This display mode is indicated by the symbol <b>F-R</b> .	Sensor

Preset: FWD  
 IEC/IEEE command: :SENSe<n>:FUNctIon[:ON] "POWER:FORWARD:..." (FWD)  
 :SENSe<n>:FUNctIon[:ON] "POWER:ABSORPTION:..." (F-R)

### 2.3.3 MAXHOLD (min/max display on/off)

The NRT is able to store the maximum and minimum values as well as the differences thereof for all measurement functions. Two menus are available for this purpose. Via the CONFig - MAXDISP menu (see following section) display of the maximum, minimum or difference value can be selected. The menu

CONFig-MAXHOLD:



allows start and stop of the max/min determination for both the power and reflection indication.

Determination of the max/min value is started by selecting the menu item *RUN*. As soon as a value is measured that is greater than the stored maximum value or smaller than the stored minimum value, the memory is updated and the displayed value corrected accordingly. After the start, the max/min memory is initialized by the first measured values.

The NRT has two sets of max/min memories, one for the power indication and one for the reflection indication. If during a max/min determination the measurement function is changed (eg from AVG to PEP), the max/min memories concerned (here: for power indication) are reinitialized and the max/min determination is started for the new measurement function.

Selection	Description	Available
RUN	Start of max/min display	Always
OFF	Stop of max/min display and return to normal measurement mode	Always

Preset: OFF  
 IEC/IEEE command: :CALCulate<n>:LIMit[:STATe] ON|OFF Start/stop min/max determination

### 2.3.4 MAXDISP (display of max value, min value or difference)

The NRT is able to store the maximum and minimum values as well as the differences thereof for all measurement functions. Two menus are available for this purpose. Via the CONFig - MAXHOLD menu (see previous section) max/min display can be started. The menu

CONFig-MAXDISP:



allows selection of the value to be displayed. The selected setting applies to both power and reflection indication. Changeover between maximum, minimum or difference display is possible any time without the ongoing max/min determination being interrupted or reinitialized.

Selection	Description	Available
MIN	Display of minimum value	Always
MAX	Display of maximum value	Always
MAX - MIN	Display of difference between maximum and minimum value	Always

Preset: MAX  
 IEC/IEEE command :CALCulate<n>:LIMit:TYPE MINimum | MAXimum | DIFFerence  
 Select max/min or difference

### 2.3.5 SCALE (Setting of Scale Limits for Bargraphs)

Scaling of the two bargraphs can be coarsely adjusted using the keys and . In the CONFig - SCALE menu the scale-end values for indication of the power (POWER) and reflection (REFL) can be set to define an individual display range.

CONFig - SCALE:



Selection	Description	Available
POWER	Entry of scale limits for power indication bargraph	Always
REFL	Entry of scale limits for reflection indication bargraph	Sensor

After confirming one of the two options by pressing the SEL(LOCAL) key, first the lower and then the upper scale limit of the bargraph is requested. The entries must be in turn confirmed with the SEL(LOCAL) key.

Preset: none (last setting)  
 IEC/IEEE command: see a) and b)

**a) Entry of lower scale limit**

CONFig - SCALE - POWER  
(REFL) - LOWER:

LOWER \* 1.8

Unit: none  
 Preset: 0.0  
 IEC/IEEE command: :SENSe<n>:POWer[:POWer]:RANGe:AUTO OFF  
 :SENSe<n>:POWer[:POWer]:RANGe:LOWer 1.8

In remote control mode, the bargraph for reflection indication is scaled with the keyword :REFlection instead of [:POWer].

**b) Entry of upper scale limit:**

CONFig - SCALE - POWER  
(REFL) - UPPER:

UPPER \* 2.1

Unit: none  
 Preset: 1.0  
 IEC/IEEE command: :SENSe<n>:POWer[:POWer]:RANGe:AUTO OFF  
 :SENSe<n>:POWer[:POWer]:RANGe:UPPer 2.1

For manual entry of the scale limits, the bargraph is operated in FIXED mode. The scale limits remain fixed and are not automatically adapted. Manual return to automatic scaling is only possible via the two scaling keys below the bargraphs (see Section 2.2.3).

The scaling of the bargraphs is dimensionless. If another unit is selected for the measured value, the scaling is not converted.

**2.3.6 RESOL (Resolution of Indication in Display)**

The CONFig - RESOL menu provides the possibility of indicating the measurement results with low (LOW) or high (HIGH) resolution.

CONFig - RESOL:

RESOL \* LOW HIGH

High resolution should be selected if very small changes of the measured values are to be displayed. To minimize flickering of the last digit, there is stronger filtering (averaging) of the measured values. The resolution setting does not affect the output format in the remote-control mode, but it does affect the measurement speed.

Selection	Description	Available
LOW	Indication of results with one digit less in the display. Weaker filtering of measured values.	Always
HIGH	Indication of results with full number of digits in the display. Stronger filtering of of measured values.	Always

Preset: depends on the sensor used  
 IEC/IEEE command: :SENSe<n>:RRESolution LOW|HIGH

### 2.3.7 INT.TIME (Setting the Integration Time)

The CONFig - INT.TIME menu allows to set the integration time for the A/D-converters in NRT-Z sensors.

CONFig - INT.TIME:



Selection	Description	Available
USER	User-defined entry of the integration time	NRT-Z
DEF	Default integration time (36.7 ms for NRT-Z43/44)	NRT-Z

Preset: DEF  
IEC/IEEE command: :SENSe<n>:POWer:APERture DEF

#### 2.3.7.1 USER (Entry of a User-Defined Integration Time)

In order to obtain a stable power indication in the operating modes AVG and AV.BRST (USER), signals which are modulated or keyed at low frequency might require the integration time to be increased beyond the default value set. The best choice consists in setting the integration time equal to the period of the envelope modulation. Low-frequency envelope modulation can also occur for digitally modulated radio signals: it is caused by the so-called idle bursts which are regularly (about all 60 ms for GSM) inserted into the transmitted signal.

Reducing the integration time will slightly increase the speed for triggered measurements provided that the measurement power is high enough to prevent automatic averaging of the results. If averaging takes place in the default setting already (in order to stabilize the indication for small powers), further reduction of the integration time will usually result in an automatic enhancement of the averaging factor so that, on the whole, no gain in the measurement speed can be achieved.

CONFig - INT.TIME - USER:

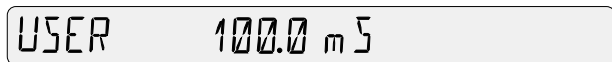

Unit: s  
Preset: depends on the sensor used  
IEC/IEEE command: :SENSe<n>:POWer:APERture 0.1s



### 2.3.8 SPEC (Special Functions)

The *CONFig - SPEC* menu allows to set the reference value for relative measurements and the SWR alarm mechanism.

*CONFig - SPEC:*

SPEC \* ΔREF SWR.ALARM

Selection	Description	Available
Δ REF	Reference value for measurement of relative power variations in dB oder %	Always
SWR.ALARM	(De-)activating SWR monitoring	Sensor

IEC-Befehle: see description of the menu items Δ REF and SWR.ALARM (Sections 2.3.8.1 and 2.3.8.2).



#### 2.3.8.1 Δ REF (Reference Value for Relative Power Measurements)

The Δ REF menu is used to define the reference value for indication of the result in the relative units % or dB (see Section 2.3.9).

*CONFig - SPEC - Δ REF:*

Δ REF \* 25.8 mW

The currently valid value is indicated upon calling up the menu. As an alternative to a user-defined reference value, the currently measured power can be used as a reference upon actuating the **ΔREF** key.

The reference value may be entered in W or dBm (use the cursor keys  and  for switchover at the units position).

Unit: W / dBm  
 Preset: 1 W  
 IEC/IEEE command: [SENSe:]POWer:REFeRence 0.0258 W

#### 2.3.8.2 SWR.ALARM (SWR Monitoring)

The *CONFig - SPEC - SWR.ALARM* function is used to configure a mechanism for monitoring the SWR of the load so that a warning can be output in the form of an acoustic or electrical signal. The menu item SWR.ALARM described here is used to define the conditions under which an alarm is to be triggered. The type of alarm has to be configured via the menu *UTIL-BEEPER* (acoustic, see section 2.5.7) or *UTIL-AUX/IO* (electrical, see section 2.5.9).

The alarm is triggered above a user-defined standing wave ratio (*SWR*). To prevent the alarm mechanism from responding at low uncritical powers, an additional threshold must be entered for the forward power (*THRESHOLD*), below which no alarm will be given.

By entering a sufficiently high power threshold (1 MW or similar), the alarm mechanism can be totally switched off. No acoustic alarm will be given for forward powers below this threshold, even if the maximum SWR is considerably exceeded.

After confirming the *SWR.ALARM* option in the *SPEC* menu, first the SWR-limit and then the power threshold is requested. The entries must be confirmed with the SEL(LOCAL) key.

a) Entry of SWR limit value:

CONFig - SPEC -  
SWR.ALARM - MAX SWR:

MAX SWR\* 30

Unit: none  
Preset: 3.0  
IEC/IEEE command: :SENSe<n>:SWR:LIMit 3.0

b) Entry of threshold for forward power:

CONFig - SPEC -  
SWR.ALARM - THRESHOLD:

THRESHOLD\* 10 W

Unit: W  
Preset: 100 MW  
IEC/IEEE command: :SENSe<n>:SWR:THReshold 10W

2.3.9 Δ KEY (Configuration of Relative Units)

The key dBm/Δ/W can be used to select the unit of the power indication: dBm, W and relative indication. The Δ KEY menu allows configuration of the relative indication. The relative difference can be indicated in % or dB, relative to the stored reference power.

CONFig - Δ KEY:

Δ KEY\* %/dB

Either the currently measured power value ([ΔREF] key in manual mode) or any other value can be entered as reference value (see Section 2.3.8.1).

Selection	Description	Available
%	Deviation of measured power from reference power in percent $P_{\%} \equiv \frac{P_{meas} - P_{ref}}{P_{ref}} \cdot 100$	Always
dB	Difference between measured power and reference power in dB. $P_{dB} \equiv 10 \cdot \log \frac{P_{meas}}{P_{ref}}$	Always

Preset: dB  
IEC/IEEE command: :UNIT<n>:POWer:RELative:STATe ON  
:UNIT<n>:POWer:RELative DB|PCT

### 2.3.10 RFL KEY (Configuration of Reflection Indication)

The CONFig - RFL KEY menu is used to select instead of the standing wave ratio (SWR) another parameter indicating the matching of the load. There is a choice between return loss (RL), reflection coefficient (R.CO) or reverse power (REV.PWR).

CONFig - RFL KEY:

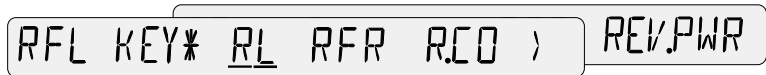

➤ Use the key  to switch between SWR and any of these display modes.

Selection	Description	Unit	Available
RL	Return loss $RL \equiv 10 \cdot \log \frac{P_F}{P_R}$	dB	Sensor
RFR	Power ratio reverse/forward $RFR \equiv 100 \cdot \frac{P_R}{P_F}$	%	Sensor
R.CO	Reflection coefficient $R.CO \equiv \sqrt{\frac{P_R}{P_F}}$	No unit	Sensor
REV.PWR	Reverse power $P_R$	W, dBm	Sensor

The SWR is the dimensionless quotient

$$SWR \equiv \left(1 + \sqrt{\frac{P_R}{P_F}}\right) / \left(1 - \sqrt{\frac{P_R}{P_F}}\right),$$

with the forward power  $P_F$  and the reverse power  $P_R$ .

Preset: R.CO  
 IEC/IEEE command: :SENSE<n>:FUNCTION[:ON] "POWER:REVerse" REV.PWR  
 :SENSE<n>:FUNCTION[:ON] "POWER:REFLection" RL, RFR, R.CO, SWR  
 :UNIT<n>:POWER:REFLection RL|R.CO|SWR|RFR

## 2.4 CORRection Menu

The CORRection menu provides functions for reducing the measurement uncertainty.

- Call up the menu with the **CORR** key.

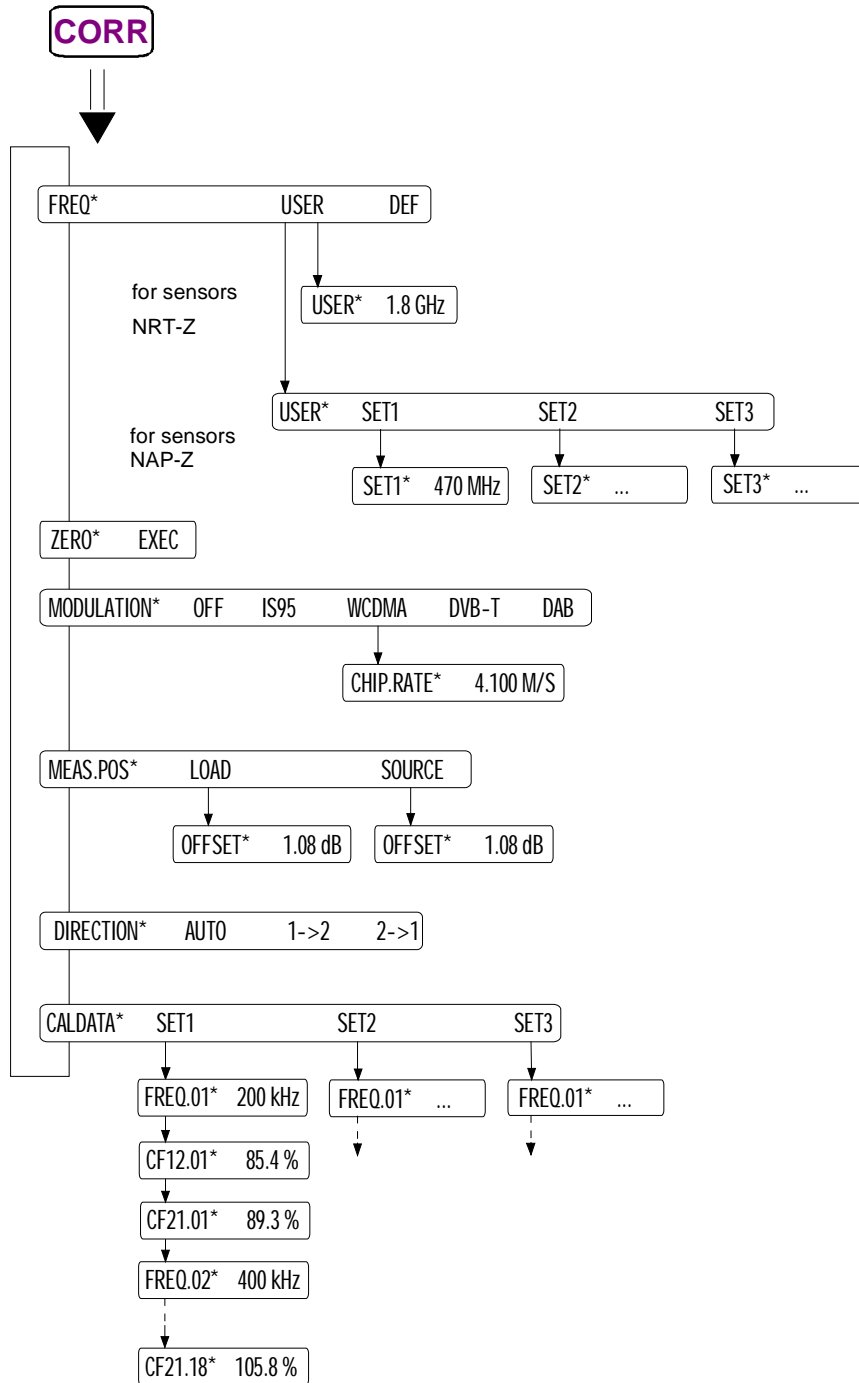

Fig. 2-6 CORRection menu

### 2.4.1 FREQ (Frequency Response Correction )

The accuracy specified for a sensor for power measurement is usually only adhered to if the carrier frequency of the test signal is known to the instrument. Only in this way is it possible to correct the measurement result with the aid of the correction factors stored in the sensor.

Frequency response correction is possible for sensors of both type NRT-Z and NAP-Z. The selected frequency can be displayed alone or with a correction value for the cable loss (see sections 2.4.4 and 2.5.10) on the readout between the bargraphs, eg in the following form:



In the *CORRection - FREQ* menu individual frequency values can be entered or a default setting can be activated.

*CORRection - FREQ:*



Selection	Description	Available
<b>USER</b>	User-defined frequency setting. Entry of the test frequency is requested in a submenu. For NAP-sensors the appropriate calibration data set must be selected first.	Always
<b>DEF</b>	For NRT-sensors, the default frequency stored in the sensor is used for correction and indicated on the display. The default frequency is sensor-specific and usually lies in the middle of the frequency range in which the frequency has little influence on the sensor characteristics.  For NAP-sensors, the frequency response correction is deactivated by using a calibration factor of 100% for both directions. No frequency is indicated.	Always

Preset: DEF  
IEC/IEEE command: :SENSe<n>:FREQuency[:CW|:FIXed] DEFault

#### 2.4.1.1 Entry of Carrier Frequency for NRT Sensors

In order to keep the error limits given in the datasheet, the frequency entered must be exact up to about one percent.

*CORRection - FREQ - USER:*



Unit: Hz  
Preset: depends on the sensor used  
IEC/IEEE command: :SENSe<n>:FREQuency[:CW|:FIXed] 1.2GHz

### 2.4.1.2 Entry of Carrier Frequency for NAP Sensors

For improving the measurement accuracy, the NAP sensors of type NAP-Z7, -Z8 and -Z42 are delivered with frequency-dependent calibration factors so that a frequency response correction is possible for those sensors, too. As the calibration factors are not stored in the sensor but available in printed form, they must be entered in the NRT prior to activating the frequency response correction (see Section 0). The NRT provides memory space for up to three sensors.

Thus selection of the relevant data set is requested before the carrier frequency is entered,.

CORRection - *FREQ* -  
USER:

USER\* SET1 SET2 SET3

Selection	Description	Available
SETm	Calibration data set relevant for the frequency response correction. m = 1, 2, 3. The data set selected must contain the calibration data appropriate for the sensor.	Always

After selecting the calibration data set the carrier frequency can be entered:

CORRection - *FREQ* - USER  
- SETm

SETm\* 1.200 GHz

Unit: Hz  
Preset: none (last setting)  
IEC/IEEE Command: :CALibration0:STATE1 OFF Calibration dataset 2 and  
:CALibration0:STATE3 OFF Corr. frequency 1,2 GHz  
:CALibration0:STATE2 ON  
:SENSe0:FREQuency[:CW|:FIXed] 1.2GHz

### 2.4.2 ZERO (Zeroing)

In particular thermal effects, such as screwing the sensor to a hot RF connector, may cause a forward and reverse power indication other than zero without an RF signal being applied. This disturbance referred to as deviation from zero is additive, ie it is added in the same amount and with same polarity to the measured value. Therefore it can be measured within a zeroing procedure and then subtracted from each measured value.

CORRection - ZERO:

ZERO\* EXEC

**Proceed as follows:**

- Switch off RF power and select *EXEC* menu with *SEL(LOCAL)* key.

The instrument signals completion of zeroing by "ZEROING..." and switches to normal power indication after approx. 4 s. For all power measurement functions except *PEP* with modulation correction (see Section 2.4.3) the deviation from zero should have disappeared except for a time-variant residual error due to the display noise.

- If the message "NO ZEROING <POWER IS ON>" is displayed, switch off RF power and repeat zeroing.

Preset: none (last setting)  
IEC/IEEE command: :CALibration<n>:ZERO

### 2.4.3 MODULATION (correction of measured values with modulated signals)

When the power of wide-band modulated signals is measured, the envelope power varies in the rhythm of the modulation. This may cause systematic deviations for all measurement functions (*AVG*, *PEP*, *CF*, *CCDF*). With NRT-Z43/44 sensors, these deviations can be reduced considerably if the properties of the signal can be taken into account during measurement data processing.

The *MODULATION* menu allows parameters to be entered that are transferred to the sensor and taken into account, e.g. the type of communication standard.

CORRection - MODULATION:

MODULATION\* OFF IS95 | WCDMA | DVB-T | DAB

Selection	Description	Available
OFF	The correction of modulation-specific deviations is switched off.	Always
IS95	Reduces systematic deviations occurring in power measurements on base stations (BTS) according to standard IS-95 CDMA.	NRT-Z
WCDMA	... on BTS according to standard WCDMA	NRT-Z
DVB-T	... on terrestrial DVB TV transmitters	NRT-Z
DAB	... on DAB radio transmitters	NRT-Z

Preset:

OFF

IEC/IEEE command:

:SENSe<n>:DM:STATe ON|OFF  
:SENSe<n>:DM:STANdard IS95|WCDMa|DVBT|DAB

Notes:

The deviations which can be compensated with the command group **CORRection - MODULATION** are proportional to power for the *AVG* and *AV.BRST* functions. Since they are only a few per cent at nominal power (30 W for NRT-Z43, 120 W for NRT-Z44), the modulation correction will practically have no effect at much lower power values, i.e. below approx. 10 W for NRT-Z44.

To enable the measurement value correction for the *PEP*, *CF*, and *CCDF* functions, the video bandwidth of the sensor must not be restricted (use setting "FULL" in the *VID.BW* submenu for the quoted measurement functions).

### Entry of the chip rate for WCDMA signals

In contrast to other communication standards WCDMA is not based on a fixed RF bandwidth but on a bandwidth which varies according to the chip rate selected. This means that, if the standard "WCDMA" is selected, the chip rate must be entered in addition (this is possible up to a maximum value of  $8.2 \cdot 10^6$  / s with NRT-Z43/44 sensors).

CORRection - MODULATION - CHIP.RATE:

CHIPRATE\* 4100 M/S

Unit:

1/s

Preset:

depending on the sensor used

IEC/IEEE command:

:SENSe<n>:DM:WCDMa:CRATe 4.1E6

### 2.4.4 MEAS.POS (Definition of Reference Plane)

In the *CORRection - MEAS.POS* menu it can be defined whether measurements are to be made at the source or load connection of the sensor.

*CORRection - MEAS.POS*:

MEAS.POS\* LOAD SOURCE

In case of more stringent requirements on the measurement accuracy the reference plane must be taken into account because the sensor absorbs part of the RF power and therefore causes the signals leaving the sensor to be smaller than the input signals (insertion loss, see Fig. 2-7).

Depending on the power quantity, the measurement must be performed on either the source or the load position. The selected reference plane is shown on the display by the **PORT** indicated.

Quantity to be measured	Load matching	Settings NRT	
		POWER	MEAS.POS
(Effective) power delivered by the source	any	F-R	SOURCE
(Effective) power absorbed by the load		F-R	LOAD
Forward power (at the source)		FWD	SOURCE
Forward power (at the load)		FWD	LOAD
Load matching		FWD / F-R	LOAD
Power of source into 50 Ω	good (SWR <1.2)	FWD	SOURCE

As the actual measurement point (output connector of the transmitter or input connector of the antenna) is often not directly accessible, the NRT also requests the entry of a cable loss (*OFFSET*) between the sensor connection and the desired measurement point (see below).

Selection	Description	Available
<b>LOAD</b>	Measurement of forward and reverse power at the <u>load</u> connector	always
<b>SOURCE</b>	Measurement of forward and reverse power at the <u>source</u> connector	MK

Preset: depending on the sensor used

IEC/IEEE command: :INPut<n>:PORT:POSition LOAD|SOURCE

With sensors of the NAP-Z type the same values are displayed in the two positions "SOURCE" and "LOAD" because the NRT is unable to take into account the insertion loss with these sensors. As the calibration of the sensors is referred to the load position, systematic deviations corresponding to the transmission loss must be expected in the "SOURCE" position. For sensors NAP-Z6/-Z7/-Z8 these deviations are smaller than 0.05 dB in the whole specified frequency range and therefore negligible. For all other sensors, deviations smaller than 0.1 dB (0.2 dB) can be expected in the following frequency ranges.

NAP-Z3/-Z9/Z10	25 MHz to 350 (500) MHz
NAP-Z4	25 MHz to 500 (800) MHz
NAP-Z5/-Z11	25 MHz to 800 (1000) MHz
NAP-Z42	900 MHz to 1500 (2000) MHz

Cable losses are correctly taken into account for these sensors, too.



**Consideration of cable losses**

After defining the reference plane the NRT requests the entry of the cable loss (*OFFSET*) between the sensor and the measurement point actually desired:

CORRection - MEAS.POS - LOAD  
(SOURCE) - OFFSET:



Unit: dB  
 Preset: depends on the sensor used.  
 IEC/IEEE command: :INPut<n>:PORT:OFFSet <Attenuation in dB>

Once the entry is terminated the power and matching values are corrected as if the measurement was carried out at the inaccessible measurement point. The entered cable loss can be indicated between the bar graphs in the middle of the display (see Section 2.5.10).

**Example 1:** Measurement of the output power of a transmitter. The sensor is connected to the output of the transmitter via a short cable with a transmission loss of 0.45 dB. Appropriate setting of the NRT: Measurement position "SOURCE" with an offset value of 0.45 dB. If no transmission loss (*OFFSET*) is taken into account the measured output power of the transmitter is 0.45 dB (i.e. 10 %) smaller than the real value!

**Example 2:** Measurement of the matching of an antenna. The sensor is connected to the input of the antenna via a longer cable with a transmission loss of 1.2 dB. Appropriate setting of the NRT: Measurement position "LOAD" with an offset value of 1.2 dB. If no transmission loss (*OFFSET*) is taken into account the measured return loss of the antenna is 2.4 dB higher than the real value!

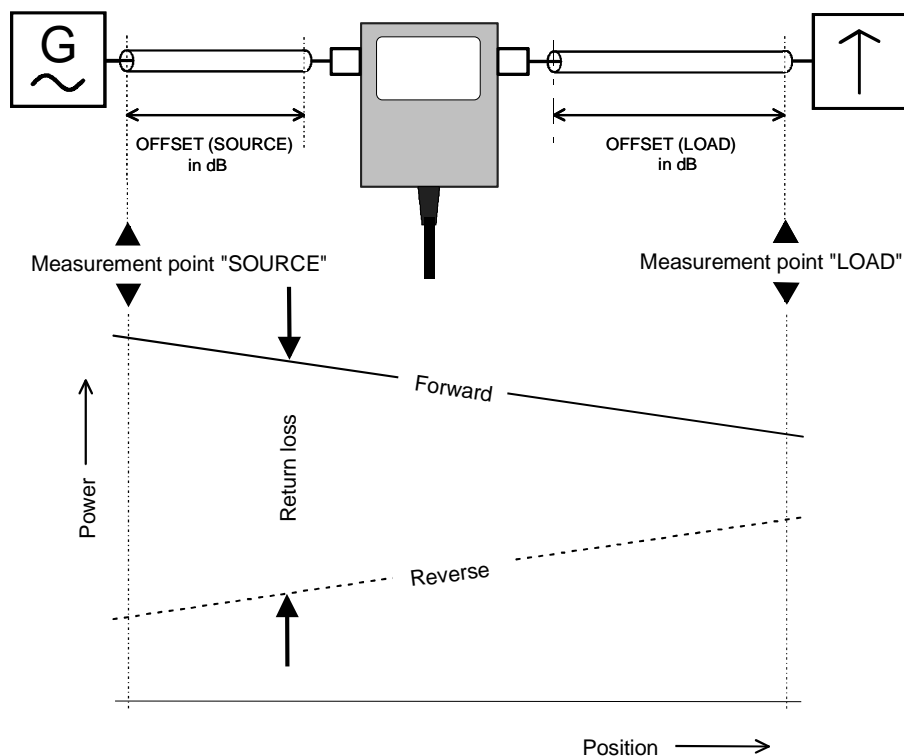

**Fig. 2-7 Definition of the measurement position**

## 2.4.5 DIRECTION (Selection of Forward Power Direction)

In the *CORRection - DIRECTION* menu the direction of the forward power can be fixed from port 1 to port 2 ( $1 \rightarrow 2$ ) and vice versa ( $2 \rightarrow 1$ ). The ports 1 and 2 are marked on each directional power sensor.

*CORRection - DIRECTION:*

Directional sensors with directional coupler are able to measure the power flow between the two RF connectors from the source to the load and vice versa. In the normal case the NRT should be set so that the greater of the two values is automatically indicated as the forward power (*AUTO* mode). Due to measurement uncertainties it may occur however that for very small powers or in case of high reflection ( $SWR \rightarrow \infty$ ) a smaller value is measured for the forward power than for the reverse power. In this case an automatic switchover of the power indication would not be advisable, since the physically available forward power would be interpreted as reverse power. This can be avoided by fixing the direction of the forward power in the *CORRection - DIRECTION* menu.

Selection	Description	Available
<b>AUTO</b>	Automatic selection of power flow direction. The greater of the two powers measured by the sensor is assumed to be the forward power.	Sensor
<b>1→2</b>	The forward power direction is fixed from port 1 to port 2.	Sensor
<b>2→1</b>	The forward power direction is fixed from port 2 to port 1.	Sensor

Preset:	depends on the sensor used	
IEC/IEEE command:	: INPut<n>: PORT: SOURce: AUTO ON	AUTO
	: INPut<n>: PORT: SOURce: AUTO OFF	(1 → 2)
	: INPut<n>: PORT: SOURce 1	
	: INPut<n>: PORT: SOURce: AUTO OFF	(2 → 1)
	: INPut<n>: PORT: SOURce 2	

Some of the directional power sensors, as for instance the NRT-Z44, have a privileged direction for the forward power, which is due to the fact that the reverse direction is more sensitive and the envelope parameters (*PEP*, *CF*, *AV.BRST* and *CCDF*) can only be measured in the privileged direction. Since it may also be advisable to operate such sensors in inverse mode (eg for measuring very small powers without measuring the *SWR*), a choice of three settings (*AUTO*,  $1 \rightarrow 2$  and  $2 \rightarrow 1$ ) is offered in this case, too.

### 2.4.6 CALDATA (Entry of Calibration Factors)

The *CORRection - CALDATA* menu allows the entry of calibration factors for NAP sensors and hence frequency-response-corrected measurements (see Section 2.4.1). Calibration factors define the ratio between uncorrected measured power and true value and are required to increase the measurement accuracy of the Power Sensors NAP-Z7, -Z8 and -Z42. R&S supplies the calibration factors for these power sensors in the form of tables with frequency-dependent calibration factors for the two measurement directions (CF12 means direction 1 → 2):

Frequency	CF12	CF21
200 kHz	85.4%	87.2%
400 kHz	91.2%	92.4%
.....	.....	.....
.....	.....	.....
.....	.....	.....
80 MHz	102.3%	99.1%

Via the CALDATA menu the NRT provides memory space for the calibration factors of three sensors in the form of three data sets.

*CORRection - CALDATA:*

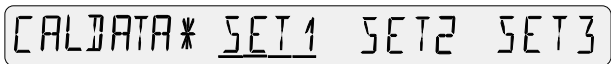

Selection	Description	Available
SETm	Data set for entry of the calibration factors for one NAP sensor. m= 1, 2, 3.	Always

The calibration factors can be entered as soon as the desired data set has been selected with the input key. The user is then prompted to enter frequency, CF12 and CF21 for the first frequency value. The stored values are indicated, which may have to be changed with the aid of the cursor keys and must then be confirmed with the input key:

*CORRection - CALDATA - SETm - FREQ.01*

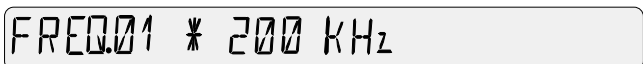

*CORRection - CALDATA - SETm - CF12.01*

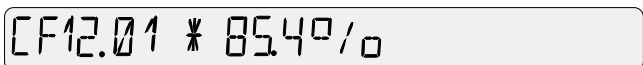

*CORRection - CALDATA - SETm - CF21.01*

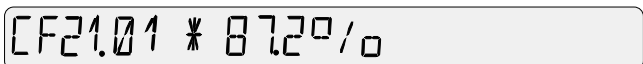

The entry is continued with the next frequency and ends with the entry of CF21 for the 18th frequency value:

*CORRection - CALDATA - SETm - FREQ.02*

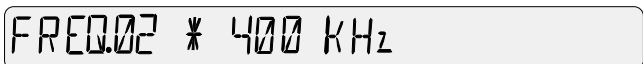

.....  
.....  
.....

*CORRection - CALDATA - SETm - CF21.18*

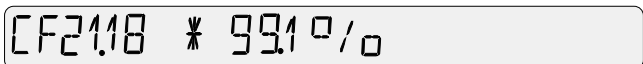

The frequency values have to be entered in ascending order, starting with the lowest frequency. If there are less than 18 frequency reference values, the entry can be terminated after the last value by pressing a key outside the menu field.

**Unit:**            Hz     for frequency,  
                  %     for calibration factors.

Via IEC/IEEE bus, frequency values and calibration factors are entered separately in complete lists:

```
CALibration0:FREQuency<m>:DATA 200E3, 400E3, ... , 80E6            Frequency list
CALibration0:LOAD<m>:DATA 85.4, 91.2, ... , 102.3                CF12
CALibration0:SOUR<m>:DATA 87.2, 92.4, ... , 99.1                CF21
```

m            ≡ number of data set (1, 2, 3)

LOAD        ≡ CF12

SOUR        ≡ CF21

## 2.5 UTILity Menu

The *UTILity* menu provides various general functions.

- Backlighting of the display on/off (*ILLUM*),
- recall and saving of instrument settings (*SETUP*),
- power management (*AUTO.OFF*, *BATTERY CHARGE*, *BATT.TIME*, *ELAPSED TIME*, *AFTER CHARGE*, *BATTERY CHARGE*),
- configuration of external interfaces (*REMOTE*, *AUX/IO*),
- beeper on/off (*BEEPER*), built-in tests (*TEST*), display configuration (*SHOW*),
- keyboard lock (*KEYBOARD LOCK*).

➤ Call up the menu with the **UTIL** key.

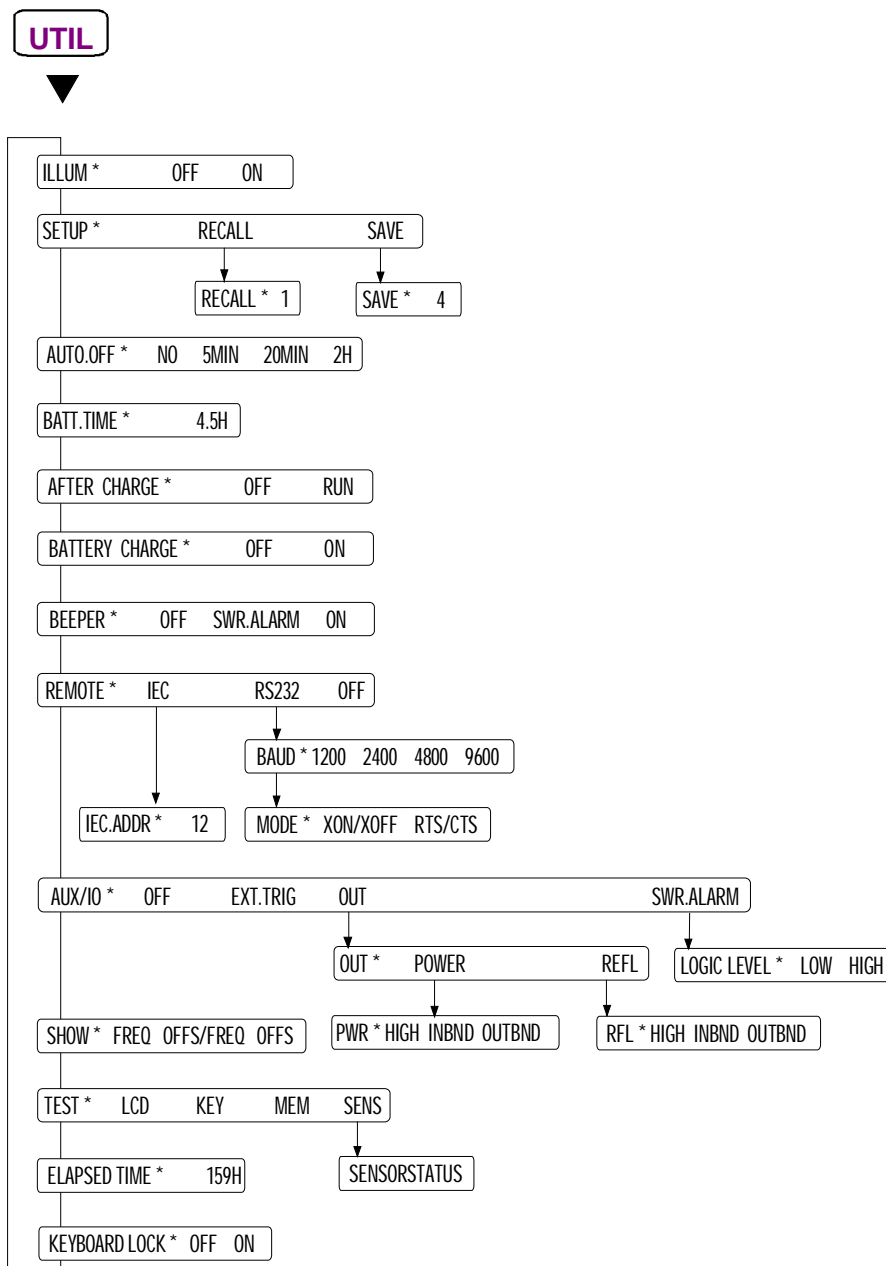
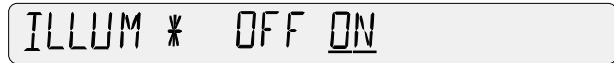

Fig. 2-8 UTILity menu

### 2.5.1 ILLUM (Switching off and on the Backlighting of the Display)

The backlighting of the NRT's display can be switched off and on via the *ILLUM* menu:

*UTILity - ILLUM:*



Selection	Description	Available
OFF	Switch off the backlighting	Always
ON	Switch on the backlighting	Always

Preset: OFF

Switching off the backlighting can be useful in battery mode because it serves to increase the battery operating time.

### 2.5.2 SETUP (Recalling and Storing Instrument Settings)

Various measurement tasks usually require a variety of instrument settings. To avoid the renewed entry of all parameters on changing the setting, the instrument provides four memories for storing complete configurations for the sensors connected.

The setup memories can be accessed via the *SETUP* menu.

*UTILity - SETUP:*



Selection	Description	Available
RECALL	Recalling setup	Always
SAVE	Storing setup	Always

It is possible to load a stored configuration with the numeric parameter *UTILity - RECALL*. The NRT then continues to operate with this setting. The current configuration is overwritten.

*UTILity -SETUP- RECALL:*

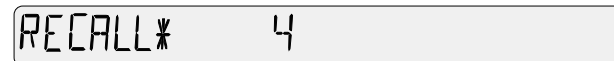

Memory 0 contains the preset parameters (preset, see annex E).

- Memories: 0 to 4
- Preset: none (last setting)
- IEC/IEEE command:
  - \*RCL 4 (Recall setting no. 4)
  - or
  - \*RST (Recall preset)
  - or
  - \*RCL 0 (Recall setting no. 0)
  - or
  - :SYSTEM:PRESet (System preset)

The current instrument setting is stored in a memory using the numeric parameter *UTILity - SAVE*. The memory is designated by a number 1 to 4. The data contained in the specified memory are overwritten. The preset parameters in memory no. 0 can not be overwritten.

*UTILity - SETUP - SAVE:*



Memories: 1 to 4  
 Preset: none (last setting)  
 IEC/IEEE command: \*SAV 9 store current setting in memory no. 4

**2.5.3 AUTO.OFF (Power-Saving Mode)**

The *UTILity - AUTO.OFF* menu provides an automatic switchoff of the NRT. This automatic switchoff is made if within the set time neither a key is pressed nor a remote-control command given.

*UTILity - AUTO.OFF:*

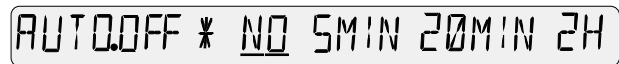

With fully charged battery and a sensor connected, the NRT can be operated without interruption for approx. 8 hours. The automatic switchoff saves power during the non-operational periods and leads to a prolonged effective operating time of the battery.

This menu is only provided if Battery Option NRT-B3 is fitted.

Selection	Description	Available
<b>NO</b>	The power-saving mode is deactivated. The instrument remains switched on until the <b>ON/STBY</b> key is actuated.	Always
<b>5min</b>	Automatic switchoff after five minutes.	NRT-B3
<b>20min</b>	Automatic switchoff after 20 minutes.	NRT-B3
<b>2h</b>	Automatic switchoff after two hours.	NRT-B3

Preset: 5 MIN  
 IEC/IEEE command: :CONTRol:POWer[:STATe] OFF Power-saving mode off  
 :CONTRol:POWer[:STATe] ON Automatic switchoff  
 :CONTRol:POWer:DELay 300s after 5 minutes

### 2.5.4 BATT.TIME (Battery Charging)

The NRT contains two meters one of which registers the battery operating time since the last complete charging of the battery. As a fully charged battery allows to operate the NRT for about 8 hours, this gives an estimate of the remaining battery capacity. The battery time is displayed via the *BATT.TIME* parameter:

UTILity - *BATT.TIME*

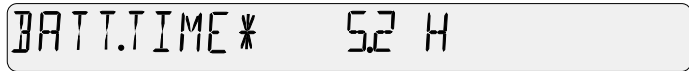

The battery counter is automatically reset after each complete charging of the battery (except for manual stop of charging, see Section 2.5.6).

Preset: none (last setting)  
 Unit: H (hour)  
 IEC\IEEE command: none

### 2.5.5 AFTER CHARGE (Automatic Switchoff after Charging)

The NRT can switch off automatically after charging. This feature should be used whenever the battery is to be fully recharged at the end of a working day – eg overnight – and the instrument is not to remain in operation after charging:

UTILity - *AFTER CHARGE:*

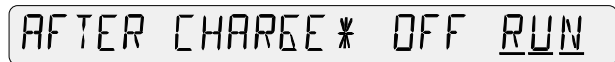

This menu item is available only if battery option NRT-B3 is installed.

Selection	Description	Available
OFF	Automatic switchoff after charging	NRT-B3
RUN	Instrument remains on	NRT-B3

Preset: RUN  
 IEC/IEEE command: :CONTrol:POWER:BATTEry:ACHarge OFF|RUN



### 2.5.6 BATTERY CHARGE (Manual Control of Battery Charging)

The Ni-MH battery provided with the NRT can be charged automatically. Charging may also be started and stopped by the user. Charging is automatically initialized whenever the instrument is connected to the AC supply after at least three hours of battery operation. Charging is indicated by the display of danger arrow and battery symbol.

Charging can be started any time manually by selecting *BATTERY CHARGE - ON*:

UTILity - BATTERY  
CHARGE:



Manual charging should be carried out whenever the NRT is to be operated without AC supply over a longer period and there is no possibility of recharging the battery during this period. Charging can however be stopped prematurely by selecting *OFF* in the charge menu or by switching off the NRT via the *ON/STBY* key.

Occasional charging of partly discharged batteries does not cause any damage. Fully charged batteries should however not be recharged repeatedly as this may cause damage in the long run.

This menu is only available if Battery Option NRT-B3 is fitted.

Selection	Description	Available
ON	Start charging	NRT-B3
OFF	Terminate charging	NRT-B3

Preset: none (last setting)  
IEC/IEEE command: :CONTrol:POWER:BATTeRY:CHARge LOAD

### 2.5.7 BEEPER (Alarm Message, Acknowledge Signal)

The *UTILity - BEEPER* menu allows the tone generator to be configured in such a way that an acoustic signal is output in the case of SWR overranging and when a key is pressed.

UTILity - BEEPER:

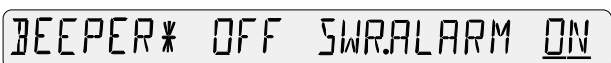

A SWR limit value and a power threshold are to be entered on the NRT (section 2.3.8.2 SWR.ALARM) so that the SWR alarm can be output acoustically. Keystrokes are acknowledged by a single beep (valid entry) or a double beep (invalid entry) if the beeper is configured accordingly.

Selection	Description	Available
OFF	The tone generator responds only if the instrument is switched on/off or the battery is discharged	Always
SWR.ALARM	Like OFF plus output of an SWR alarm	Always
ON	Like OFF plus output of an SWR alarm and acknowledgement of keystrokes	Always

Preset: SWR.ALARM  
IEC/IEEE command: SYSTem:BEEPer:STATe ON|OFF ON / OFF  
[SENSe<n>:]SWR:SIGNal BEEPer SWR Alarm

### 2.5.8 REMOTE (Remote-Control Settings)

In the *REMOTE* menu the remote-control interface that is to be active is selected. Simultaneous operation of the two interfaces is not possible.

UTILity - REMOTE:



Selection	Description	Available
<b>IEC</b>	The IEC/IEEE-bus interface (to IEC 625.1/IEEE 488.2 Standard) fitted as standard is activated. The IEC/IEEE-bus address can be set in a submenu.	Always
<b>RS232</b>	The serial interface is switched on. A submenu is displayed for specification of the transfer rate (baud rate) and the handshake mode.	Always
<b>OFF</b>	With this setting, both interfaces are switched off. This is to save power and to extend the battery operation time.	Always

Preset: IEC/IEEE  
IEC/IEEE command: none

#### a) Setting the device address on the IEC/IEEE bus:

UTILity - REMOTE - IEC - IEC.ADDR:

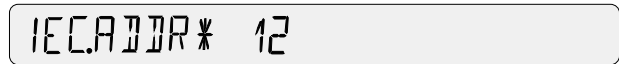

Range: 0 to 30  
Preset: none (last setting)  
Factory setting: 12  
IEC/IEEE bus: SYSTEM:COMMunicate:GPIB[:SELF]:ADDRESS 12

#### b) Setting the serial interface

The instrument requests baud rate and handshake mode:

UTILity - REMOTE - RS232 - BAUD:

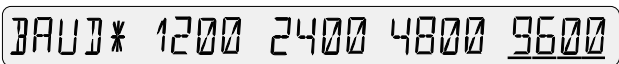

Selection	Description	Available
<b>1200</b> <b>2400</b> <b>4800</b> <b>9600</b>	Baud rate for serial transmission (in bits per second).	Always

Preset: none (last setting)  
Factory setting: 9600  
IEC/IEEE command: :SYSTEM:COMMunicate:SERial[:RECeive]:BAUD 9600

After the baud rate the handshake mode has to be specified. The handshake mode defines the way in which the instrument signals to its communication partner (eg a PC) that it is ready to receive data.

UTILity - REMOTE - RS232 -  
MODE:



Selection	Description	Available
XON/XOFF	Software handshake via control characters XON and XOFF.	Always
RTS/CTS	Hardware handshake via control lines RTS and CTS.	Always

Preset: none (last setting)  
 Factory setting: XON/XOFF  
 IEC/IEEE command: :SYSTem:COMMunicate:SERial:CONTRol:RTS OFF XON/XOFF  
 :SYSTem:COMMunicate:SERial[:RECeive]:PACE XON  
 :SYSTem:COMMunicate:SERial:CONTRol:RTS RFR RTS/CTS  
 :SYSTem:COMMunicate:SERial[:RECeive]:PACE NONE

**Note:** For configuration of the communication partner it should be considered that the NRT is basically set for the transmission of 10 bits: 1 start bit, 8 data bits, 1 stop bit, no parity bit.

### 2.5.9 AUX/IO (Configuration of IN/OUT Connector)

In the UTILITY – AUX/IO menu the function of the BNC connector (AUX TTL) is set. This connector is for universal use and located on the rear panel of the instrument.

UTILity – AUX/IO:

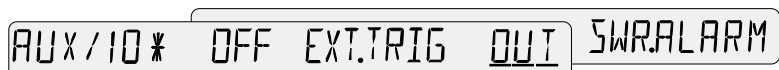

Selection	Description	Available
OFF	The AUX TTL connector is switched as input, but has no function.	Always
EXT.TRIG	The AUX TTL connector operates as an external trigger input. Measurement is triggered by a positive signal edge. Trigger events during ongoing measurements are ignored.  <b>In manual mode:</b> No free-running measurements in this mode. The result display is frozen between two trigger events.  <b>In remote mode:</b> The NRT can be triggered by a trigger command (eg *TRG) or via the AUX TTL connector, depending on which of the events occurs sooner.	Always

<b>OUT</b>	Control connector: A logic low/high signal is output at this connector if the measured power or SWR values are within or out of the range limits defined for the bargraphs. In a submenu either the lefthand (power) or the righthand bargraph (SWR) can be selected and the response exactly defined.	Always
<b>SWR.ALARM</b>	Outputs a TTL signal with selectable level (see description of submenu) if the conditions for a SWR warning are fulfilled (see section 2.3.8.2).	

The input/output signals at the AUX connector are TTL-compatible.

Preset:	OFF	
IEC-Befehl:	:SENSE<n>:POWer[:POWer]:RANGe:LIMit[:STATE] OFF :SENSE<n>:POWer:REFLection:RANGe:LIMit[:STATE] OFF :SENSE<n>:SWR:SIGNal NONE   BEEPer :TRIGger:SOURce INTernal	OFF
	:SENSE<n>:POWer[:POWer]:RANGe:LIMit[:STATE] OFF :SENSE<n>:POWer:REFLection:RANGe:LIMit[:STATE] OFF :SENSE<n>:SWR:SIGNal NONE   BEEPer :TRIGger:SOURce EXTernal	EXT.TRIG

The remote-control commands for the OUT and SWR ALARM modes are described in the following sections.

### 2.5.9.1 Configuration as a Monitoring Output: Selection of Bargraph

In the *OUT* menu the bargraph to which the output signal is to be referred is selected.

UTILity – AUX/IO – OUT:



Selection	Description	Available
<b>POWER</b>	Monitoring is selected for the lefthand bargraph	Always
<b>REFL</b>	Monitoring is selected for the righthand bargraph	Sensor

Preset: none (last setting)

### 2.5.9.2 Entering the Monitoring Criteria

After selecting the bargraph the NRT requests the entry of monitoring criteria. The selection is equal for both bargraphs.

With the parameters *HIGH*, *INBND* and *OUTBND* the conditions are defined under which the test signal generates a high level (> 3 V) at the AUX connector. If the conditions are not fulfilled, low level (< 0.8 V) will be output.

UTILity – AUX/IO – OUT –  
POWER (REFL):

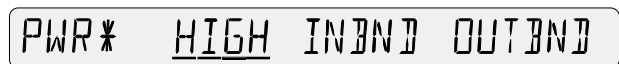

Selection	Description	Available
<b>HIGH</b>	If the measured value exceeds the upper scale limit, a high signal (> 3 V) will be output.	Always
<b>INBND</b>	If the measured value is within the two scale limits, a high signal (> 3 V) will be output.	Always
<b>OUTBND</b>	If the measured value is out of the two scale limits, a high signal (> 3 V) will be output.	Always

Preset: HIGH

IEC/IEEE command: :TRIGger[:TRIGger]:SOURce INTernal  
 :SENSE<n>:SWR:SIGNal NONE | BEEPer  
 :SENSE<n>:POWER:REFlection:RANGE:LIMit[:STATE] OFF  
 :SENSE<n>:POWER[:POWER]:RANGE:AUTO OFF  
 :SENSE<n>:POWER[:POWER]:RANGE:LIMit[:STATE] ON POWER  
 :SENSE<n>:POWER[:POWER]:RANGE:LIMit:DETECT  
 HIGH | INBound | OUTBound  
 :TRIGger[:TRIGger]:SOURce INTernal  
 :SENSE<n>:SWR:SIGNal NONE | BEEPer  
 :SENSE<n>:POWER[:POWER]:RANGE:LIMit[:STATE] OFF  
 :SENSE<n>:POWER:REFlection:RANGE:AUTO OFF  
 :SENSE<n>:POWER:REFlection:RANGE:LIMit[:STATE] ON REFL  
 :SENSE<n>:POWER:REFlection:RANGE:LIMit:DETECT  
 HIGH | INBound | OUTBound

### 2.5.9.3 Selection of Output Level for SWR Alarm

This menu item is used to configure the electrical output signal in the case of an SWR alarm.

UTILITY – AUX/IO – SWR.ALARM –  
 LOGIC LEVEL:

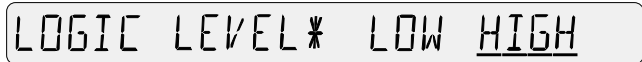

Selection	Description	Available
<b>LOW</b>	Outputs a LOW level in the case of an SWR alarm (< 0.8 V)	Always
<b>HIGH</b>	Outputs a HIGH level in the case of an SWR alarm (> 3 V).	Always

Preset: HIGH

IEC/IEEE command: :SENSE<n>:POWER[:POWER]:RANGE:LIMit[:STATE] OFF  
 :SENSE<n>:POWER:REFlection:RANGE:LIMit[:STATE] OFF  
 :SENSE<n>:SWR:SIGNal TTLSignal | BOTH  
 :SENSE<n>:SWR:SIGNal[:TTLSignal]:LEVel LOW | HIGH

### 2.5.10 SHOW (Display of Correction Frequency and/or Cable Loss)

The UTILity - SHOW menu allows the configuration of the small central readout for displaying the parameters correction frequency (section 2.4.1) and/or cable loss (section 2.4.4):

UTILity - SHOW:

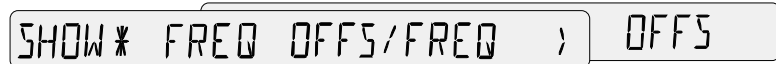

Selection	Description	Available
<b>FREQ</b>	Display of the entered correction frequency in MHz or GHz, e.g.: <b>@ 1.090 GHz.</b> <sup>1)</sup>	Always
<b>OFFS/FREQ</b>	Combined display of cable loss in dB and correction frequency in GHz (in this mode frequency is always displayed without unit ), e.g.: <b>2.04dB 1.09</b> <sup>2)</sup>	Always
<b>OFFS</b>	Display of cable loss in dB, e.g.: <b>2.04dB.</b>	Always

- <sup>1)</sup> The correction frequency is not displayed when a NAP sensor without frequency response correction (default) is used.
- <sup>2)</sup> The cable attenuation is not displayed for an attenuation value of 0 dB. In this case the frequency is displayed with a unit (MHz, GHz).

Preset: FREQ  
IEC/IEEE command: none



### 2.5.11 TEST (Built-in Tests)

The TEST menu allows a selftest of the various NRT components.

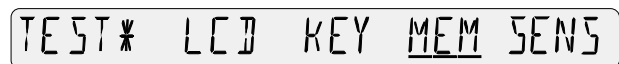
UTILity – TEST:



Selection	Description	Available
<b>LCD</b>	Display test: All segments of the display are shown until the <b>LOCAL SEL</b> key is pressed.	Always
<b>KEY</b>	Keypad test: Each key actuated is shown with its designation in the display. The only exception is the <b>ON/STBY</b> key which switches the NRT to the standby mode. The keypad test can be terminated by pressing the same key twice.	Always

<b>MEM</b>	<p>Memory test:</p> <p>All three memories available in the NRT are successively tested: flash EPROM, RAM and FRAM. The test covers addressing errors and faulty memory locations.</p>	Always
<b>SENS</b>	<p>Sensor test: The status of the active sensor is queried. First an identification string for the connected sensor is displayed, e.g.:</p> <p style="padding-left: 40px;">NRT-Z44 V 1.40</p> <p>with sensor type and firmware version number.</p> <p>Afterwards one of the four cursor keys, e.g. , can be pressed to display the error messages which may exist, e.g.</p> <p style="padding-left: 40px;">TEMPERATURE                      ERR</p> <p> CAL. VALUES CHECKSUM      ERR</p> <p>Via IEC/IEEE-bus, the error messages can be queried using :TEST:SENsOr? (see Section 3.5.14).</p>	Always

Preset: none (function call)  
 IEC/IEEE command: :TEST[:ALL]? Memory test

### 2.5.12 ELAPSED TIME (Elapsed Time Meter)

*ELAPSED TIME* is a value giving the operating time of the NRT in hours. See also Section 2.5.4.

UTILity – *ELAPSED TIME*:

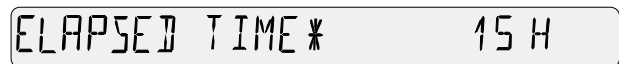

Unit: H (hour)  
 Preset: none (last setting)  
 IEC/IEEE command: none

**2.5.13 KEYBOARD LOCK (Locking the Keyboard)**

This function enables the user to lock the entire keyboard including the ON/STBY key. This feature is helpful, for example, if you wish to protect a defined NRT setting against unauthorized access.

UTILity - KEYBOARD LOCK



Selection	Description	Available
OFF	Keyboard not locked	always
ON	Keyboard locked	always

Preset: OFF

IEC/IEEE command: none

To return to the keyboard-not-locked state, switch off the power and switch it on again. If the NRT is connected to the AC supply, it is absolutely necessary to unplug the power cable. If option NRT-B3 is fitted, remove also the battery.



## 3 Remote Control

### Introduction

The instrument is equipped with an IEC/IEEE-bus interface according to standard IEC 625.1/IEEE 488.1 and a RS-232 interface. The connectors are located at the rear of the instrument and permit to connect a controller for remote control.

The instrument supports the SCPI version 1994.0 (Standard Commands for Programmable Instru-ments). The SCPI standard is based on standard IEEE 488.2 and aims at the standardization of device-specific commands, error handling and the status registers (see Section 3.4.1, "SCPI Introduction").

This section assumes basic knowledge of IEC/IEEE-bus programming and operation of the controller. A description of the interface commands can be obtained from the relevant manuals.

The requirements of the SCPI standard placed on command syntax, error handling and configuration of the status registers are explained in detail in the respective sections. Tables provide a fast overview of the commands implemented in the instrument and the bit assignment in the status registers. The tables are supplemented by a comprehensive description of every command and the status registers. Detailed programming examples of the essential functions can be found in Annex D. The examples are all written in QuickBASIC.

**Note:** *In contrast to manual control, which is intended for maximum possible operating convenience, the priority of remote control is the "predictability" of the device status. This means that when incompatible settings (e.g. simultaneous activation of an average (AVG) and PEP-measurement) are attempted, the command is ignored and the device status remains unchanged, i.e. is not adapted to other settings. Therefore, IEC/IEEE-bus control programs should always define an initial device status (e.g. with the command \*RST) and then implement the required settings.*

### 3.1 Brief Instructions

The short and simple operating sequence given below permits to put the instrument into operation quickly and set its basic functions.

#### 3.1.1 IEC/IEEE-bus

It is assumed that the NRT is connected to the power supply and the IEC/IEEE-bus address is set to 12 (factory setting).

- Connect instrument to controller using IEC/IEEE-bus cable.
- Write and start the following program on the controller (for <n> insert the number of the selected sensor port (0: NRT-B1, 1: front panel connector)):

CALL IBFIND("DEV1", sensor%)	Open port to the instrument
CALL IBPAD(sensor%, 12)	Inform controller about instrument address
CALL IBWRT(sensor%, "*RST;*CLS;*WAI")	Reset instrument
CALL IBWRT(sensor%, ":SENS<n>:FREQ DEF")	Switch off frequency response correction
CALL IBWRT(sensor%, ":SENS<n>:POW:REF 27dBm")	Set reference power to 27 dBm
CALL IBWRT(sensor%, ":SENS<n>:FUNC 'POW:FORW:AVER'")	Switch on average power measurement

CALL IBWRT(sensor%, ":UNIT<n>:POW:REL:STAT ON")	Activate relative units for forward measured values
CALL IBWRT(sensor%, ":UNIT<n>:POW:REL PCT")	Set relative units to %
CALL IBWRT(sensor%, "*TRG")	Trigger
CALL IBRD(sensor%, measured_value)	Read measurement result

The instrument measures the average forward power of a signal and displays the deviation relative to the reference value in units of percent.

- To return to manual control, press the **LOCAL SEL** key at the front panel.

### 3.1.2 RS-232 Interface

It is assumed that the baud rate at the NRT is set to 9600 and the handshake mode is set to XON/OFF (factory setting, see Section 2.5.8).

- Connect NRT and controller using the zero-modem cable (see Annex A, "Interfaces").
- Enter the following command at the controller (under DOS) to configure the controller interface:  
mode com<x>: 9600, n, 8, 1                    <x>=1 or 2, according to connector used.
- Create the following ASCII file at the controller (for <m> insert the number of the sensor port used (0:NRT-B1, 1: front panel connector):
 

*RST; *CLS; *WAI	Reset instrument
:SENS<m>:FREQ DEF	Frequency response correction
:SENS<m>:POW:REF 27dBm	Set reference power to 27 dBm
:SENS<m>:FUNC "POW:FORW:AVER"	Switch on average power measurement
:UNIT<m>:POW:REL:STAT ON	Activate the display of forward measured values in relative units
:UNIT<m>:POW:REL PCT	Set relative unit to %
*TRG	Trigger
	(Blank line)
- Transfer ASCII file to unit via RS-232 interface. To this end, enter the following command at the controller (under DOS):

copy <filename> com<x>:

The instrument measures the average forward power of a signal and displays the deviation relative to the reference value in units of percent.

- To return to manual control, press the **LOCAL SEL** key at the front panel.

## 3.2 Switchover to Remote Control

On power-on, the instrument is always in the manual operating state ("LOCAL" state) and can be operated via the front panel controls. For remote control, the desired interface (IEC/IEEE-bus or RS-232) must be first selected and configured via the *UTILity – REMOTE* menu (see Section 2.5.8). Afterwards the instrument is switched to remote control ("REMOTE" state):

when IEC/IEEE-bus is active	as soon as it receives an addressed command from a controller.
when the RS-232 interface is active	as soon as it receives either a carriage return <CR> (=0Dh) or a line feed <LF> (0Ah) from a controller.

The operation via the front panel is disabled. The instrument remains in the remote state until it is reset to the manual state via the front panel or via IEC bus (see Sections 3.2.1.3 and 3.2.2.3, Return to Manual Operation). Switching from manual operation to remote control resets the NRT automatically from cyclic to external triggering. All other settings remain unaffected.

### 3.2.1 Remote Control via IEC Bus

#### 3.2.1.1 Setting the Device Address

The IEC/IEEE-bus address of the instrument is factory-set to 12. It can be changed manually in the *UTILity - REMOTE - IEC - IEC.ADDR* menu or via IEC bus. Addresses 0 to 30 are permissible.



##### Manually:

- Call *UTILity - REMOTE - IEC - IEC.ADDR* menu,
- Enter desired address,
- Terminate input using the  key.

##### Via IEC bus:

<code>CALL IBFIND("DEV1", sensor%)</code>	Open port to the instrument
<code>CALL IBPAD(sensor%, 12)</code>	Inform controller about old address
<code>CALL IBWRT(sensor%, "SYST:COMM:GPIB:ADDR 20")</code>	Set instrument to new address
<code>CALL IBPAD(sensor%, 20)</code>	Inform controller about new address

#### 3.2.1.2 Indications during Remote Control



The active state of the remote control is indicated by the symbol **REM** on the display. The symbol **LLO** indicates that the  key is disabled, i.e. switchover to manual operation is only possible via IEC/IEEE bus. When **LLO** is not indicated, switchover to manual control is possible via the  key (see also section 3.2.1.3, Return to Manual Operation).

### 3.2.1.3 Return to Manual Operation

Return to manual operation is possible via the front panel or the IEC bus.

**Manually:** ➤ Press the  key.

**Notes:**

- Before switchover, command processing must be completed as otherwise switchover to remote control is effected immediately.
- The  key can be disabled by the universal command `LLO` (see Annex A, Interfaces) in order to prevent unintentional switchover. In this case, switchover to manual mode is only possible via the IEC bus.
- The  key can be enabled again by deactivating the `REN` control line of the IEC bus (see annex A).

**Via IEC bus:**

```
...
CALL IBLOC(sensor%)           Set instrument to manual operation.
...
```

In contrast to standard IEEE 488.2, the NRT is reset from external to cyclic triggering upon returning to manual operation. All other settings remain unaffected.

## 3.2.2 Remote Control via RS-232-Interface

### 3.2.2.1 Setting the Transmission Parameters

To enable an error-free and correct data transmission, the parameters of the unit and the controller must be set identically. To prevent any problems during binary data transmission, the RS-232 interface of the NRT is set for 8 data bits, no parity and 1 stop bit. The baudrate and the handshake mode can be manually changed in the `UTILity - REMOTE - RS232` menu.

- Call `UTILity - REMOTE - RS232` menu
- Select desired baudrate
- Select desired handshake
- Terminate input using the  key

### 3.2.2.2 Indications during Remote Control

The active state of the remote control is indicated by the symbol "REM" on the display.

### 3.2.2.3 Return to Manual Operation

Return to manual operation is possible via the front panel.

- Press the LOCAL  
SEL key.

**Note:** *Before switchover, command processing must be completed as otherwise switchover to remote control is effected immediately.*

## 3.3 Messages

The messages transferred via the data lines of the IEC bus (see annex A) can be divided into two groups:

- **interface messages**
- **device messages**

### 3.3.1 Interface Message

Interface messages are transferred on the data lines of the IEC bus, the ATN control line being active. Interface messages are used for communication between controller and instrument and can only be sent by a computer which has the function of an IEC/IEEE-bus controller.

Interface commands can be further subdivided into

- **universal commands**
- **addressed commands**

Universal commands act on all devices connected to the IEC bus without previous addressing, addressed commands only act on devices previously addressed as listeners. The interface messages relevant to the NRT are listed in Annex A.1.4).

Some control characters are also defined for the control of the RS-232-interface (see Annex A.2.4).

### 3.3.2 Device Messages (Commands and Device Responses)

Device messages are transferred via the data lines of the IEC bus, the "ATN" control line not being active. The ASCII code is used. The device messages are largely identical for the two interfaces (IEC/IEEE-bus and RS-232). A distinction is made according to the direction in which device messages are transferred:

– **Commands** are messages the controller sends to the instrument. They operate the device functions and request information. The commands are subdivided according to two criteria:

1. According to the effect they have on the instrument:

**Setting commands** cause instrument settings such as reset of the instrument or setting the output voltage to 1 Volt.

**Queries** cause data to be provided for output on the IEC/IEEE-bus, e.g. for identification of the device or polling the active input.

2. According to their definition in standard IEEE 488.2:

**Common Commands** are exactly defined as to their function and notation in standard IEEE 488.2. They refer to functions such as management of the standardized status registers, reset and selftest.

**Device-specific Commands** refer to functions depending on the features of the instrument such as frequency setting. A majority of these commands has also been standardized by the SCPI committee (cf. Section 3.4.1, "SCPI Introduction").

– **Device responses** are messages the instrument sends to the controller after a query. They can contain measurement results, instrument settings and information on the instrument status (cf. Section 3.4.4, "Responses to Queries").

Structure and syntax of the device messages are described in Section 3.4. The commands are listed and explained in detail in Section 3.5.

## 3.4 Structure and Syntax of the Device Messages

### 3.4.1 SCPI Introduction

SCPI (Standard Commands for Programmable Instruments) describes a standard command set for programming instruments, irrespective of the type of instrument or manufacturer. The goal of the SCPI consortium is to standardize the device-specific commands to a large extent. For this purpose, a model was developed which defines the same functions inside a device or for different devices. Command systems were generated which are assigned to these functions. Thus it is possible to address the same functions with identical commands. The command systems are of a hierarchical structure. Fig. 3-1 illustrates this tree structure using a section of command system SOURce, which operates the signal sources of the devices. The other examples concerning syntax and structure of the commands are derived from this command system.

SCPI is based on standard IEEE 488.2, i.e. it uses the same syntactic basic elements as well as the common commands defined in this standard. Part of the syntax of the device responses is defined with greater restrictions than in standard IEEE 488.2 (see Section 3.4.4, "Responses to Queries").

### 3.4.2 Structure of a Command

Commands consist of a so-called header and, in most cases, one or more parameters. Header and parameter are separated by a "white space" (ASCII code 0 to 9, 11 to 32 decimal, e.g. blank). The headers may consist of several key words. Queries are formed by directly appending a question mark to the header.

**Note:** *The commands used in the following examples are not in every case implemented in the NRT.*

## Common Commands

Common (=device-independent) commands consist of a header preceded by an asterisk "\*" and eventually one or several parameters.

### Examples:

\*RST                    RESET, resets the instrument.  
 \*ESE 253              EVENT STATUS ENABLE, sets the bits of the event status enable registers.  
 \*ESR?                 EVENT STATUS QUERY, queries the contents of the event status register.

## Device-specific commands

**Hierarchy:** Device-specific commands are of hierarchical structure (see Fig. 3-1). The different levels are represented by combined headers. Headers of the highest level (root level) have only one key word. This key word denotes a complete command system.

### Example:

:SENSe<n>      This key word denotes the command system :SENSe<n>.

For commands of lower levels, the complete path has to be specified, starting on the left with the highest level, the individual key words being separated by a colon ":".

### Example:

:SENSe<n>:POWer:POWer:RANGe:LIMit:STATe ON

This command is located on the sixth level of the SENSe system. It switches on the control function for the power indication. ON is one of the two possible parameters of this command.

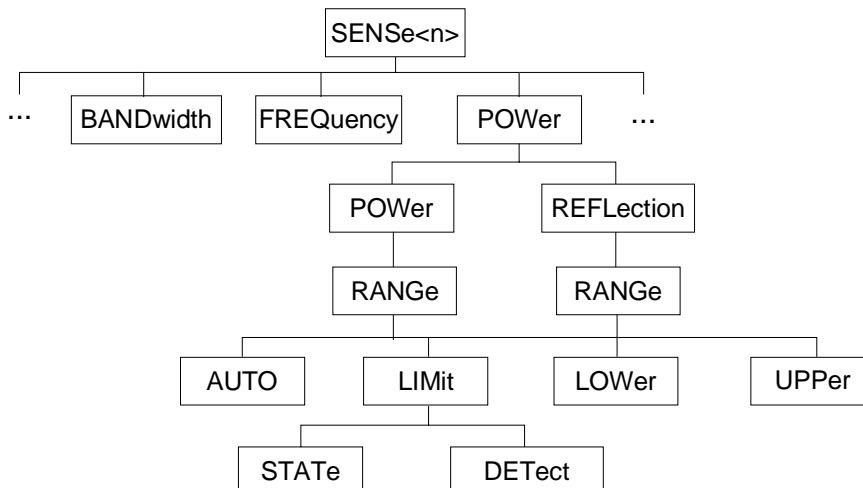

**Fig. 3-1** Example for the tree structure of the SCPI command systems: The SENSe system

### Multiple key words

Some key words occur on several levels within one command system. Their effect depends on the structure of the command, i. e. on the position in the command header they are inserted in.

- Example:**       :SENSe1:SWR:LIMit 20.0
- This command contains the key word LIMit in the third command level. The command defines the acoustic monitoring of the standing wave ratio (SWR).
- :SENSe1:POWer:POWer:RANGe:LIMit:STATe ON
- This command contains the key word LIMit in the fifth command level. It switches on the control function for the power indication.
- Optional key words:** Some command systems permit certain key words to be optionally inserted into the header or omitted. These key words are marked by square brackets in this manual. The full command length must be recognized by the instrument for reasons of compatibility with the SCPI standard. Some commands are considerably shortened by omitting optional key words.
- Example:**       :SENSe1:POWer[:POWer]:RANGe[:UPPer] 50
- This command defines the upper limit for the left bargraph. The following command has the same effect:
- :SENS1:POW:RANG 50
- Note:**         *An optional key word must not be omitted if its effect is additionally specified by a numeric suffix.*
- Long and short form:** The key words feature a long form and a short form. Either the short form or the long form can be entered, other abbreviations are not permissible.
- Example:**       :STATus:QUEStionable:ENABle 1  
                  :STAT:QUES:ENAB 1
- Note:**         *The short form is marked by upper-case letters, the long form corresponds to the complete word. Upper-case and lower-case notation only serves to distinguish the two forms in the manual, the instrument itself does not distinguish upper-case and lower-case letters.*
- Parameters:** Parameters must be separated from the header by a "white space". If several parameters are specified in a command, they are separated by a comma ",". A few queries permit the parameters MINimum, MAXimum and DEFault. For a description of the types of parameter, refer to Section 3.4.5, "Parameter".
- Example:**       :SENSe1:POWer:REFerence? MAXimum Antwort:100MW
- This query requests the maximum reference value.
- Numeric suffix:** If a device features several functions or features of the same kind, e.g. inputs, the desired function can be selected by a suffix added to the command. Entries without suffix are interpreted like entries with the suffix 1.
- Example:**       :SENSe2:RRESolution HIGH
- This command defines the resolution of measured result at sensor no. 2.



### 3.4.3 Structure of a Command Line

A command line may consist of one or several commands. It is terminated by a <New Line>, a <New Line> with EOI or an EOI together with the last data byte. Quick BASIC automatically produces an EOI together with the last data byte.

Several commands in a command line must be separated by a semicolon ";". If the next command belongs to a different command system, the semicolon is followed by a colon.

**Example:** `CALL IBWRT(sensor%, ":SENSe2:BURSt:MODE USER;  
:INPut2:PORT:SOURce 1")`

This command line contains two commands. The first command belongs to the SOURce system and specifies the burst parameters. The second command belongs to the OUTPut system and sets the direction of the forward measurement.

If the successive commands belong to the same system, having one or several levels in common, the command line can be abbreviated. To this end, the second command after the semicolon starts with the level that lies below the common levels (see also Fig. 3-1). The colon following the semicolon must be omitted in this case.

**Example:** `CALL IBWRT(sensor%, ":SENSe2:BURSt:PERiod 50 ms;  
:SENSe2:BURSt:WIDth 10 ms")`

This command line is represented in its full length and contains two commands separated from each other by the semicolon. Both commands are part of the SENSe command system, subsystem BURSt, i.e. they have two common levels.

When abbreviating the command line, the second command begins with the level below SOURce:FM. The colon after the semicolon is omitted.

The abbreviated form of the command line reads as follows:

`CALL IBWRT(sensor%, ":SENSe2:BURSt:PERiod 50 ms;WIDth 10 ms")`

However, a new command line always begins with the complete path.

**Example:** `CALL IBWRT(sensor%, ":SENSe2:BURSt:PERiod 50 ms")  
CALL IBWRT(sensor%, ":SENSe2:BURSt:WIDth 10 ms")`

### 3.4.4 Responses to Queries

A query is defined for each setting command unless explicitly specified otherwise. It is formed by adding a question mark to the associated setting command. According to SCPI, the responses to queries are partly subject to stricter rules than in standard IEEE 488.2.

1. The requested parameter is transmitted without header.

**Example:** `:INPut1:PORT:POSition?` Response: LOAD

2. Maximum values, minimum values and all further quantities, which are requested via a special text parameter are returned as numerical values.

**Example:** `:INPut1:PORT:SOURce? MAX` Response: 2

3. Numerical values are output without a unit. Physical quantities are referred to the basic units or to the units set using the Unit command.

**Example:** `:SENSe3:FREQuency?` Response: 1E6 for 1 MHz





**3.4.6 Overview of Syntax Elements**

- :** The colon separates the key words of a command.  
In a command line the separating semicolon marks the uppermost command level.
  
- ;** The semicolon separates two commands of a command line.  
It does not alter the path.
  
- ,** The comma separates several parameters of a command.
  
- ?** The question mark forms a query.
  
- \*** The asterisk marks a common command.
  
- "**  
Double or single quotation marks introduce a string and terminate it.
  
- '**
  
- #** The double dagger # introduces block data.
  
- A "white space" (ASCII-Code 0 to 9, 11 to 32 decimal, e.g. blank) separates header and parameter.

## 3.5 Description of Commands

### 3.5.1 Notation

In the following sections, all commands implemented in the instrument are first listed in tables and then described in detail, separated according to the command systems. The notation corresponds to the one of the SCPI standards to a large extent. The SCPI conformity information can be taken from the list of commands in annex C.

#### Table of Commands

Command:	The command column provides an overview of the commands and their hierarchical arrangement (see below, "indentations").
Parameter:	The parameter column indicates the requested parameters together with their specified range.
Unit:	The unit column indicates the basic unit of the physical parameters.
Remark:	In the remark column, all commands are indicated <ul style="list-style-type: none"> <li>- which do not have a query form,</li> <li>- which have only one query form ,</li> <li>- which are implemented only in conjunction with a certain option of the instrument.</li> </ul>

#### Indentations

The different levels of the SCPI command hierarchy are represented in the table by means of indentations to the right. The lower the level is, the farther the indentation to the right is. Please observe that the complete command syntax always includes the higher levels.

**Example:**    :SENSE<n>:SWR:LIMit  
                  is represented in the table as follows:

:SENSe<n>:	first level
SWR	second level
:LIMit	third level

In its individual description, the command is given in its complete form. A programming example for each command is given at the end of the description.

#### Upper/lower case notation

Upper/lower case letters serve to mark the long or short form of the key words of a command in the description (see Section 3.4.2, "Structure of a Command"). The instrument itself does not distinguish between upper and lower case letters.

**Special characters** | A selection of *key words* with identical effect exists for several commands. These key words are indicated in the same line, they are separated by a vertical stroke. Only one of these key words has to be specified in the header of the command. The effect of the command is independent of which of the key words is specified.

<b>:SENSe&lt;n&gt;:</b>	first level
<b>:FREQUency</b>	second level
<b>:CW :FIXed</b>	third level

**Example:**

**:SENSe<n>:FREQUency:CW 1E6** is equivalent to  
**:SENSe<n>:FREQUency:FIXed 1E6**

A vertical stroke between the *parameters* marks alternative possibilities in the sense of "or". The effect of the command is different, depending on which parameter is entered.

Example: Selection of the parameters for the command

```
SENSe:RRESolution LOW | HIGH
```

If the parameter HIGH is selected, the measurement is performed with higher accuracy.

[ ] *Key words* in square brackets can be omitted when composing the header (cf. Section 3.5.2, Optional Keywords). The full command length must be accepted by the instrument for reasons of compatibility with the SCPI standards.

*Parameters* in square brackets are optional and can be omitted.

{ } *Parameters* in braces are optional. They can either be omitted, or incorporated in the command once or several times.

<n> This sign marks the numeric suffix "sensor port".

<n> ∈ 0 .. 3

0: Rear-panel connector for NAP-sensors (option NRT-B1),

1: Front-panel connector (standard),

2,3: Rear-panel connectors (option NRT-B2).

### 3.5.2 Trigger and Measurement during Remote Control

The NRT provides the trigger modes **external trigger** and **freerun mode**.

The **external trigger mode** (:TRIG:SOUR EXT) is set by the NRT as a default mode for remote control upon each switchover from local to remote operation. In this mode the measurement can be triggered by an external signal only.

The NRT recognizes the following equivalent trigger events:

- the IEC-commands \*TRG, READ? and TRIG,
- a positive signal ramp at the external trigger input AUX TTL on the rear panel of the instrument.

#### \*TRG

The command **\*TRG** (Common Command) triggers a measurement and returns the measured result in the ASCII format.

```
CALL IBWRT(sensor%, "*TRG")
CALL IBRD(sensor%, Measvalue$)
PRINT Measvalue$
Indication e. g.: +4.00730E+00,+4.00560E-01
```

#### READ?

The command **READ?** (Measurement Instruction) is equivalent to the command \*TRG. However, the measured values are transmitted as binary data.

```
CALL IBWRT(sensor%, "READ?")
CALL IBRD(sensor%, Measvalue$)
PRINT Measvalue$
Indication e.g.: #18→QÇ@±ϕ±>
```

#### TRIG

The command **TRIG** (Subsystem TRIGger) only triggers a measurement. After the measurement is terminated the result can be queried any time by sending the command SENS<n>:DATA?. With the command \*WAI, written in the same command line as TRIG, the NRT is commanded to terminate the measurement before executing the next command line.

```
CALL IBWRT(sensor%, "TRIG;*WAI")
CALL IBWRT(sensor%, "SENS<n>:DATA?")
CALL IBRD(sensor%, Measvalue$)
PRINT Measvalue$
Indication e.g.: +4.00730E+00,+4.00560E-01
```

For **external triggering via a TTL-signal at the AUX TTL connector** the controller doesn't generally send the trigger event itself. In order to recognize the end of a measurement, it can order the NRT to generate a service request SRQ when a triggered measurement is terminated. As soon as the SRQ arrives at the controller, the measured result can be queried by the command SENS<n>:DATA? .

**Programming example**

for external triggering via the AUX TTL-conector:

```

*****
'Initialize the SRQ
*****
CALL IBWRT(sensor%, "*CLS")           'Reset Status Reporting
CALL IBWRT(sensor%, "*SRE 128")      'Enable SRQ for STAT:OPER
CALL IBWRT(sensor%, "*ESE 61")      'Enable SRQ at NRT with
                                     'Event-Enable-Bit
CALL IBWRT(sensor%, "STAT:OPER:ENAB 16") 'Activate MEASuring-Operation-
                                     'Enable-Bit
CALL IBWRT(sensor%, "STAT:OPER:NTR 16") 'Trigger SRQ as soon as the NRT
                                     'has terminated the measurement.

*****
'Activate SRQ at Controller
*****
ON PEN GOSUB Srq
PEN ON

*****
'Main Program
*****
'Application-specific commands, Examples for querying the measured results
flag% = 0
lp = TRUE
WHILE lp = TRUE           'Reading the data within a loop
IF flag% = 1 THEN         'triggered measurement terminated
CALL IBWRT(sensor%, "SENS<n>:DATA?") 'query data
CALL IBRD(sensor%, Measval$)
PRINT "current meas. value: " ; Measval$ 'and print them
flag% = 0
PEN ON                     'Activate SRQ again
END IF
WEND
STOP                       'End of program

*****
Srq:                        'Service Request Routine
*****
CALL IBRSP(sensor%, STB%)  'Serial poll, read status byte
IF (STB% AND 128) > 0 THEN GOSUB Operationstatus
ON PEN GOSUB Srq
PEN ON
RETURN                     'End of service request routine

*****
Operationstatus: 'Subroutine for handling the OPER-register
*****
Oper$ = SPACE$(20)
CALL IBWRT(sensor%, "STAT:OPER:EVEN?")
CALL IBRD(sensor%, Oper$)
IF (VAL(Oper$) AND 16) > 0 THEN flag% = 1
RETURN                     'End of subroutine

```



In the **freerun mode** (:TRIG:SOUR INT) measurements are performed continuously. In this operating mode, the last measured result can be queried with the command SENS<n>:DATA?. In this case the time when the response arrives and the time of the measurement are not correlated.

In the freerun mode the trigger commands \*TRG, READ? and TRIG may be used as well. However, the measurement running at the time of the trigger event is only terminated before the external trigger starts a new measurement. Therefore no time offset must be tolerated.

### 3.5.3 Selection of Measurement Channel

Up to four sensors can be connected to the NRT and individually addressed. In remote-control mode, switchover between the individual measurement channels is effected by the numeric suffix <n> (see section 3.5.1). Most commands triggering sensor-specific settings or querying measured values contain the numeric suffix in the first keyword, e.g. in

```
:SENS1:FREQ DEF
```

for switching off the frequency response correction in channel 1.

Commands without numeric suffix, such as

```
:TEST:SENSor? and
```

```
:TEST:DIRect[?] <sensor command>
```

(see Section 3.5.14, TEST Subsystem) as well as trigger commands (eg \*TRG) always refer to the current measurement channel, which is the channel addressed last by a setting command or query with numeric suffix. To avoid frequent switchover, commands with the same numeric suffix should be sent successively and not interleaved with other commands.

### 3.5.4 Common Commands

The common commands are taken from the IEEE 488.2 (IEC 625-2) standard. They have the same effect on all devices. The headers of these commands consist of an asterisk "\*" followed by three letters. Many common commands refer to the status reporting system which is described in detail in Section 3.7.

Table 3-1 Common Commands

Command	Parameter	Remark
*CLS		Clear Status; no query
*ESE	0...255	Event Status Enable
*ESR?		Standard Event Status Query; only query
*IDN?		Identification Query; only query
*IST?		Individual Status Query; only query
*OPC		Operation Complete
*OPT?		Option Identification Query; only query
*PRE	0...255	Parallel Poll Register Enable
*PSC	0   1	Power On Status Clear
*RCL	0...4	Recall; no query
*RST		Reset; no query
*SAV	1...4	Save; no query
*SRE	0...255	Service Request Enable
*STB?		Read Status Byte Query; only query
*TRG		Trigger; no query
*TST?		Self Test Query; only query
*WAI		Wait-to-Continue

**\*CLS**

**CLEAR STATUS** sets the status byte (STB), the standard event register (ESR) and the EVENT-part of the QUEStionable and the OPERation register to zero. The command does not alter the mask and transition parts of the registers. It clears the output buffer

**\*ESE 0 to 255**

**EVENT STATUS ENABLE** sets the event status enable register to the value indicated. The query \*ESE? returns the contents of the event status enable register in decimal representation.

**\*ESR?**

**STANDARD EVENT STATUS QUERY** returns the contents of the event status register in decimal representation (0 to 255) and subsequently sets the register to zero.

**\*IDN?**

**IDENTIFICATION QUERY** queries the instrument identification.

The device response is for example: "Rohde&Schwarz, NRT02,837105/007, 1.03"  
 03 = variant identification  
 837105/007= serial number  
 1.03 = firmware version number

**\*IST?**

**INDIVIDUAL STATUS QUERY** returns the contents of the IST flag in decimal representation (0 | 1). The IST flag is the status bit which is sent during a parallel poll (cf. Section 3.7.3.2, IST Flag and Parallel Poll Enable Register (PPE)).

**\*OPC**

**OPERATION COMPLETE** sets bit 0 in the event status register when all preceding commands have been executed. This bit can be used to initiate a service request (cf. Section 3.6).

**\*OPT?**

**OPTION IDENTIFICATION QUERY** queries the options included in the instrument and returns a list of the options installed. The options are separated from each other by means of commas. For every option, a fixed position is provided in the response.

**Table 3-2 Device Response to \*OPT?**

Position	Response	Description
1	NRT-B1	Sensors NAP-Z
2	NRT-B2	Two rear entries for sensors NRT-Z
3	NRT-B3	Ni-MH accumulator with built-in battery charger

Example for a complete device response: 0,NRT-B2,0

**\*PRE 0 to 255**

**PARALLEL POLL REGISTER ENABLE** sets the parallel poll enable register to the value indicated. Query \*PRE? returns the contents of the parallel poll enable register in decimal representation.

**\*PSC 0 | 1**

**POWER ON STATUS CLEAR** determines whether the contents of the ENABLE registers is maintained or reset in switching on.

\*PSC 0 causes the contents of the status registers to be maintained. Thus a service request can be triggered in switching on in the case of a corresponding configuration of status registers ESE and SRE.

\*PSC 1 resets the registers.

Query \*PSC? reads out the contents of the power-on-status-clear flag. The response can be 0 or 1.

**\*RCL 0 to 4**

**RECALL** calls the instrument state which was stored under the number concerned using command \*SAV. The effect of \*RCL x is identical with the manual selection of setup x. \*RCL 0 sets the instrument to the default state (see also \*RST command and annex E).

**\*RST**

**RESET** sets the instrument to the defined default status (see annex E).

**\*SAV 1 to 4**

**SAVE** stores the current instrument state under the number indicated (cf. \*RCL as well).

**\*SRE 0 to 255**

**SERVICE REQUEST ENABLE** sets the service request enable register to the value indicated. Bit 6 (MSS mask bit) remains 0. This command determines under which conditions a service request is triggered. Query \*SRE? reads the contents of the service request enable register in decimal representation. Bit 6 is always 0.

**\*STB?**

**READ STATUS BYTE QUERY** reads out the contents of the status byte in decimal representation.

**\*TRG**

**TRIGGER** triggers a measurement. The result can be directly read with an IEC-readout command (e.g. IBRD...). See Section 3.5.2, Trigger and Measurement during Remote Control.

**\*TST?**

**SELF TEST QUERY** triggers all selftests of the instrument indicated in Section 3.5.14, TEST Subsystem, and outputs an error code in decimal representation.

**\*WAI**

**WAIT-to-CONTINUE** only permits to execute the subsequent commands after all preceding commands have been completely executed (cf. Section 3.7, Status Reporting System and "\*OPC" as well).

### 3.5.5 Measurement Instructions

According to the SCPI convention, the purpose of measurement instructions is to acquire data. Most of the measurement instructions exhibit both command and query characteristics.

In the NRT the measurement instruction READ? is implemented as follows:

**READ?**

Like the common command \*TRG, READ? triggers a measurement but returns the result in binary form (see chapter 3.5.2, Trigger and Measurement during Remote Control).

### 3.5.6 CALCulate Subsystem

The CALCulate subsystem provides the commands for determining the min/max values. All settings refer to the sensor addressed (suffix <n>, see Section 3.5.1).

**Table 3-4** CALCulate subsystem

Command	Parameter	Unit	Notes
:CALCulate<n> :LIMit [:STATe] :TYPE	ON   OFF MINimum   MAXimum   DIFFerence		

<n> = 0 to 3

#### :CALCulate<n>:LIMit

This node controls the determination of min/max limit values of the NRT.

#### :CALCulate<n>:LIMit[:STATe] ON | OFF

These commands are used to start (ON) or stop (OFF) the search for the min/max values, which covers the measurement functions set under subsystem :SENSE<n>: FUNCTION [:ON] <measurement function>. The min/max memories are automatically reset upon start. During a search for the max/min values, the value set under subsystem :CALCulate<n>:LIMit:TYPE (maximum, minimum or the difference thereof) is returned to a request for data, not however the currently measured value. The request for data is in the form of the query :SENSE<n>: DATA?.

**Example:** :CALC1:LIM ON

\*RST value: OFF

#### :CALCulate<n>:LIMit:TYPE MINimum | MAXimum | DIFFerence

These commands allow selection of the value to be output:

MINimum	Minimum value
MAXimum	Maximum value
DIFFerence	Difference between maximum and minimum value

**Example:** :CALC1:LIM:TYPE MAX

\*RST value:MAX



**:CALibration0:STATe<m> ON | OFF**

This command activates the relevant calibration data set (ON) for the frequency response correction. The command must be sent to the NRT prior to the entry of the test frequency (see Section 2.4.1.2, Entry of Carrier Frequency for NAP Sensors). Only one calibration data set shall be active, all others must be switched off (OFF). Entry of the calibration data is described further below.

**Example:** :CAL0:STAT1 OFF \*RST value: OFF  
 :CAL0:STAT3 OFF  
 :CAL0:STAT2 ON  
 :SENS0:FREQ 1.2GHz

**:CALibration0:FREQUency<m>:DATA <Frequency Array>**

This command allows the frequencies for the individual calibration points to be entered. The frequencies shall be entered as a parameter list in the sequence specified by the manufacturer, ie starting with the lowest value. The individual frequencies are to be separated by a comma.

**Example:** :CAL0:FREQ2:DATA 0.9E9,1.0E9,...,2.0E9 No \*RST value

**:CALibration0:LOAD<m>:DATA <Calibration Factor Array CF12>**

This command is used to transfer the calibration factors for measurement direction 1→2 (CF12) into the selected calibration data set. The sequence should be in accordance with the calibration frequencies. In the following example the calibration factor of 96.5 % would refer to the frequency of 1 GHz from the previous example:

**Example:** :CAL0:LOAD2:DATA 95.2,96.5,...,104.2 No \*RST value

**:CALibration0:SOURce<m>:DATA <Calibration Factor Array CF21>**

This command is used to transfer the calibration factors for measurement direction 2→1 (CF21) into the selected calibration data set. The sequence should be in accordance with the calibration frequencies.

**Example:** :CAL0:SOUR2:DATA 98.4,99.8,...,98.1 No \*RST value





### 3.5.9 DIAGnostic Subsystem

The DIAGnostic subsystem generally contains commands providing information on the operating state of the system. The count of the elapsed-time meter can be output on the NRT.

**Table 3-7** DIAGnostic subsystem

Command	Parameter	Unit	Notes
:DIAGnostic :INFO :OTIME?		h	Query only

#### :DIAGnostic:INFO:OTIME?

This command returns the count of the built-in elapsed-time meter . The count is always output in hours [h] and cannot be changed from outside.

The command is in the form of a query and therefore has no \*RST value.

**Example:** :DIAG:INFO:OTIM?

Response: e.g. 27

### 3.5.10 INPut Subsystem

The INPut subsystem contains all commands for defining the reference plane and the forward direction for directional power sensors. All other settings referring to the measurement task are made in the SENSE subsystem.

The INPUT subsystem is only available for direction sensors with directional coupler. The sensor is selected by defining the numeric suffix <n>.

**Table 3-8 INPut subsystem**

Command	Parameter	Unit	Notes
:INPut<n> :PORT :POSition :OFFset :SOURce :AUTO	SOURce   LOAD 0 dB...100 dB   MINimum   MAXimum   DEFault 1   2   DEFault ON   OFF	dB	

<n> ∈ 0..3 (sensor port)

#### :INPut<n>:PORT:POSition SOURce | LOAD

This command selects the reference plane. It defines the sensor port to which the measurement results are to be referred to.

SOURce referred to source.  
LOAD referred to load.

**Example:** :INP2:PORT:POS SOUR \*RST value: sensor-dependent

#### :INPut<n>:PORT:OFFSet 0...100 dB | MINimum | MAXimum | DEFault

This command allows the transmission loss in a cable connecting the desired measurement point and the sensor to be taken into account. If the measurement position is set to LOAD (:INPut<n>:PORT:POSition LOAD) the cable is assumed to be connected between the sensor and the load, otherwise between the sensor and the source.

**Example:** :INP1:PORT:OFFS 1.25 \*RST value: sensor-dependent

#### :INPut<n>:PORT:SOURce 1 | 2 | DEFault

This command has to be used for defining the forward direction if the automatic assignment has been switched off with the command INPut:PORT:SOUR:AUTO OFF (see below).

The forward direction is defined by stating the source RF connector (1, 2 or DEFault). For sensors with hardware-defined privileged direction, the default setting causes selection of exactly this privileged direction as forward direction (eg NRT-Z44). Otherwise the DEFault setting is identical with the selection of port 1 as the source RF connector. The numbers 1 and 2 are clearly shown on the case or type label of each directional sensor.

**Example:** :INP2:PORT:SOUR 1 \*RST value: sensor-dependent

**:INPut<n>:PORT:SOURce:AUTO ON | OFF**

This command switches the automatic assignment of the forward direction on or off.

- With automatic assignment of the forward direction, the direction in which the greater power flows is taken as the forward direction.
- If the automatic assignment is switched off, eg to obtain a clear assignment in the case that forward and reverse power are almost equal, the orientation of the sensor is to be defined with the command :INPut<n>:PORT:SOURce.

**Example:**   :INP2:PORT:SOUR:AUTO OFF

\*RST value: sensor-dependent

### 3.5.11 SENSe Subsystem

The SENSe subsystem provides all important commands for the configuration of the measurement (eg test frequency, video bandwidth and reference power) and setting of the measurement function (eg average forward power or SWR). Further command in the SENSe subsystem refer to the settings of the bargraphs and the configuration of SWR monitoring.

The definition of the reference plane (source or load) and the assignment of the forward direction belong to the INPut subsystem (see previous section).

All settings made in the SENSe subsystem only apply to the specified sensor with the numeric suffix <n>:

- 0 : Rear-panel connector on option NRT-B1
- 1 : Front-panel connector (standard)
- 2, 3 : Rear-panel connectors (option NRT-B2)

**Note:** The keyword *SENSe* may be omitted for <n>=1 so that the following two commands are equivalent:

```
:SENSe1:FUNCTION "POWER:FORWARD:AVERAGE"
FUNCTION "POWER:FORWARD:AVERAGE"
```

**Table 3-9 SENSe subsystem**

Command	Parameter	Unit	Notes
:SENSe<n>:  BANDwidth   BWIDth :VIDeo :FNUMBER	<f>		Settings are sensor-dependent, see table 2-1.
BURSt :MODE	AUTO   USER		
:PERiod	0 to 1 s   MINimum   MAXimum	s	
:WIDTh	0 to 1 s   MINimum   MAXimum	s	
DM :STATe	ON   OFF		
:STANdard	IS95   WCDMA   DVBT   DAB		Settings are sensor-dependent
:WCDMa :CRATe	0...8.2 E 6   MINimum   MAXimum   DEFault	s <sup>-1</sup>	Settings are sensor-dependent
FREQuency [:CW]:FIXED]	0 to 200 GHz   MINimum   MAXimum   DEFault	Hz	Settings are sensor-dependent
RRESolution	LOW   HIGH		
FUNCTion :CONCurrent	ON   OFF		
:OFF	<Measurement Function>		See command description
:ALL<m>			

Command	Parameter	Unit	Notes
<p><b>[:ON]</b></p> <p><b>:STATe?</b></p>	<p>&lt;Measurement Function&gt;:                      "POWer:CFActor",                      "POWer:FORWard:AVERAge",                      "POWer:FORWard:AVERAge:BURSt",                      "POWer:FORWard:PEP",                      "POWer:FORWard:CCDFunction",                      "POWer:ABSorption:AVERAge",                      "POWer:ABSorption:AVERAge:BURSt"                      "POWer:ABSorption:PEP",                      "POWer:REVerse",                      "POWer:S11   POWer:REFlection"                      &lt;Measurement Function&gt;</p>		<p>See command description                      sensor-dependent</p> <p>sensor-dependent                      sensor-dependent                      sensor-dependent                      sensor-dependent                      sensor-dependent                      sensor-dependent                      sensor-dependent</p> <p>Query only                      See command description</p>
<p><b>DATA?</b></p> <p><b>INFormation?</b></p> <p><b>POWer</b></p> <p>    <b>:APERture</b></p> <p>    <b>:REference</b></p> <p>    <b>:CCDFunction:REference</b></p> <p>    <b>[:POWer]</b></p> <p>        <b>:RANGe</b></p> <p>            <b>:AUTO</b></p> <p>            <b>:LIMit</b></p> <p>                <b>[:STATe]</b></p> <p>            <b>:DETECT</b></p> <p>            <b>:LOWer</b></p> <p>                <b>[:UPPer]</b></p> <p>    <b>:REFlection</b></p> <p>        <b>:RANGe</b></p> <p>            <b>:AUTO</b></p> <p>            <b>:LIMit</b></p> <p>                <b>[:STATe]</b></p> <p>            <b>:DETECT</b></p> <p>            <b>:LOWer</b></p> <p>                <b>[:UPPer]</b></p>	<p>[[SENSe:]&lt;Measurement Function&gt;                        SENSe[:&lt;Measurement Function&gt;]]</p> <p>0.005s ... 0.111s   MINimum   MAXimum                        DEFault</p> <p>0 to 100E6W   -200 to 200dBm                        MINimum   MAXimum</p> <p>0 to 100E6W   -200 to .200 dBm                        MINimum   MAXimum</p> <p>ON   OFF</p> <p>ON   OFF</p> <p>INBound   OUTBound   HIGH</p> <p>-1999.0 to +1999.0   MINimum   MAXi-                      mum   DEFault</p> <p>-1999.0 to +1999.0   MINimum   MAXi-                      mum   DEFault</p> <p>ON   OFF</p> <p>ON   OFF</p> <p>INBound   OUTBound   HIGH</p> <p>-1999.0 to +1999.0   MINimum   MAXi-                      mum   DEFault</p> <p>-1999.0 to +1999.0   MINimum   MAXi-                      mum   DEFault</p>	<p>dependg.                      on UNIT</p> <p>s</p> <p>W   dBm</p> <p>W   dBm                        dB</p>	<p>Query only                      See command description</p> <p>Query only                      Sensor-dependent</p> <p>Settings are sensor-                      dependent</p>



**:SENSe<n>:DM**

This node provides the commands for correction of the measurement value for modulated signals (see Section 2.4.3).

**:SENSe<n>:DM:STATe ON | OFF**

This command switches the correction of the measurement value for modulated signals on or off. Selection of a communication standard (see below) is enabled only if the correction is switched on.

**Example:** :SENS1:DM:STAT ON \*RST value: OFF

**:SENSe<n>:DM:STANdard IS95 | WCDMa | DVBT | DAB**

This command selects the communication standard. Which settings are available depends on the sensor used. The settings are valid only if the modulation correction is switched on via the :INPut<n>:DM:STATe ON command.

**Example:** :SENS1:DM:STAN IS95 \*RST value: none (last setting)

**:SENSe<n>:DM:WCDMa:CRATe 0..8.2E6 | MINimum | MAXimum | DEFault**

This command defines the chip rate for the communication standard WCDMA. The allowed range is sensor-dependent; the value is always entered without the unit ( $s^{-1}$ ).

**Example:** :SENS1:DM:WCDM:CRAT 4.096E6 \*RST value: sensor-dependent

**:SENSe<n>:FREQUency[:CW|:FIXED] 0 to 200 GHz | MINimum | MAXimum | DEFault**

This command informs the NRT of the carrier frequency of the specified sensor.

The entered frequency value is required to correct the frequency-dependent response of the sensor. For this purpose NRT sensors contain a ROM with all sensor-specific data. For NAP sensors frequency-dependent calibration factors can be entered via the CALibration system (see Section 3.5.7, CALibration Subsystem).

**Example:** :SENS1:FREQ 10 MHz \*RST value: DEF (sensor-dependent)

**:SENSe<n>:RRESolution LOW | HIGH**

This command changes the measurement resolution. This has an effect on the accuracy of the measurement, its duration, and on the number of digits indicated in the display.

**Example:** :SENS1:RRES LOW \*RST value: sensor-dependent

**:SENSe<n>:FUNCTion**

This node provides all measurement functions.

**:SENSe<n>:FUNCTion:CONCurent ON | OFF**

This command defines whether several measurement functions may be simultaneously activated.

**OFF** Only a single function can be active. If a new measurement function is switched on, the previously active function is switched off automatically.

**ON** Two measurement functions may be simultaneously active. If two measurement functions are mutually exclusive, the error message –221 "Settings conflict" is generated and the first setting retained. All POW:FORW and POW:ABS functions are mutually exclusive. This applies also to the POW:REV and POW:S11 functions.

**Example:** :SENS2:FUNC:CONC ON \*RST value: ON

**:SENSe<n>:FUNCTION:OFF** <Measurement Function>

This command switches off a specified measurement function. If the command is in the form of a query, the headers of all switched-off measurement functions will be returned in the sequence defined under [SENS<n>:]FUNC:ON.

The command is a function call or query and therefore has no \*RST value.

**Example:** :SENS2:FUNC:OFF "POW:REV"

:SENS2:FUNC:OFF?

The following response would be possible:

"POW:CFAC", "POW:FORW:AVER:BURS", "POW:FORW:PEP", "POW:FORW:CCDF",  
"POW:ABS:AVER", "POW:ABS:AVER:BURS", "POW:ABS:PEP", "POW:REV"

**:SENSe<n>:FUNCTION:OFF:ALL<m>**

This command switches off all measurement functions referring to a specific channel no. <m>, i. e., ...ALL1 switches off all forward measurement functions, ...ALL2 switches off all measurement functions in the reverse channel.

The command is a function call and therefore has no \*RST-value.

**Example:** :SENS1:FUNC:OFF:ALL1

**:SENSe<n>:FUNCTION[:ON]** <Measurement Function>

This command switches on a specified measurement function. If this command is in the form of a query, the headers of all switched-on measurement functions (maximum of two functions) are returned.

The command is a function call or query and therefore has no \*RST value.

The following measurement functions are available:

"POWer:CFACtor"	Crest Factor	Sensor
"POWer:FORWard:AVERAge"	Average power (forward)	Always
"POWer:FORWard:AVERAge:BURSt"	Average burst power (forward)	Always
"POWer:FORWard:PEP"	Peak envelope power (forward)	Sensor
"POWer:FORWard:CCDFunction"	Cumulative distribution function of PEP	Sensor
"POWer:ABSorbtion:AVERAge"	Average absorbed power (F-R)	Sensor
"POWer:ABSorbtion:AVERAge:BURSt"	Average absorbed burst power (F-R)	Sensor
"POWer:ABSorbtion:PEP"	Absorbed peak envelope power (F-R)	Sensor
"POWer:REVerse"	Reverse power	Sensor
"POWer:S11"   "POWer:REFlection"	Matching of load. The UNIT system defines whether the output is in form of SWR, return loss, reflection coefficient, or power ratio R/F.	Sensor

A query returns the responses in the above sequence.

**Example:** :SENS2:FUNC "POW:REV"

:SENS2:FUNC?

A possible response is:

"POW:FORW:AVER", "POW:REV"





**:SENSe<n>:POWer:REFerence** 0..100E6 W | -200..+200dBm | MINimum | MAXimum

This command enters the reference values (in W or dBm) for the relative power indication (in %, dB, or dBm), see Section 2.3.8.1). Units: Watt or dBm.

**Example:** :SENS1:POW:REF 10W \*RST value: 1W

**:SENSe<n>:POWer:CCDFunction:REFerence** 0 to 100E6 W | -200 to +200 dBm | MINimum | MAXimum

This command defines the threshold for the cumulative distribution function (CCDF). The distribution function states the probability (in %) of the envelope power lying above the threshold. Units: W or dB or dBm

**Example:** :SENS2:POW:CCDF:REF 10W \*RST value: sensor-dependent

**:SENSe<n>:POWer[:POWer]:RANGe**

This node provides all commands for setting the lefthand bargraph (power indication) and for configuring the AUX TTL connector as an output for power monitoring.

**Note:** *Differing from the specifications of the SCPI Standard for RANGe commands, these command do not set the measurement range of the NRT but only define a display or tolerance range.*

**:SENSe<n>:POWer[:POWer]:RANGe:AUTO** ON | OFF

This command switches the automatic adaptation of the bargraph scaling to the measured power value on or off. If autoranging has been selected, the scale limits of the bargraphs are automatically adapted to the current measured value. If autoranging is switched off, the limits and hence the scale remain fixed.

**Example:** :SENS1:POW:RANG:AUTO OFF \*RST value: ON

**:SENSe<n>:POWer[:POWer]:RANGe:LIMit[:STATe]** ON | OFF

This command can be used to define the AUX TTL connector as a monitoring output for the power indication (ON state). In OFF state, the connector may be defined either as a monitoring output for the matching or as a trigger input.

If the AUX TTL connector is assigned more than one function, the error message –221 "Settings conflict" is generated and the first setting retained.

**Example:** :TRIG:SOUR INT  
:SENS1:POW:REFL:RANG:LIM OFF  
:SENS1:POW:RANG:LIM ON \*RST value: OFF

**:SENSe<n>:POWer[:POWer]:RANGe:LIMit:DETect** INBound | OUTBound | HIGH

This command defines the conditions for a logic high level (> 2.7 V) being output at the AUX TTL connector if this connector has been defined as a monitoring output for the power indication (eg with the command :SENSe<n>:POWer:RANGe:LIMit ON).

**OUTBound** A high level is output if the measured power is **out of** the range defined by the scale limits of the lefthand bargraph.

**INBound** A high level is output if the measured power is **within** the range specified by the scale limits of the lefthand bargraph.

**HIGH** A high level is output if the measured power exceeds the upper scale limit of the lefthand bargraph.

**Example:** :SENS1:POW:RANG:LIM:DET INB \*RST value: HIGH



**:SENSe<n>:POWER:REFlection:RANGe:LIMit:DETECT** INBound | OUTBound | HIGH

This command defines the conditions for a logic high level (> 2.7 V) being output at the AUX TTL connector if this connector has been defined as a monitoring output for the reflection indication (eg with the command POWER:REFL:RANGe:LIMit ON).

OUTBound	A high level is output if the measured reflection value is <b>out of</b> the range defined by the scale limits of the righthand bargraph.
INBound	A high level is output if the measured reflection value is <b>within</b> the range defined by the scale limits of the righthand bargraph.
HIGH	A high level is output if the measured reflection value exceeds the upper scale limit of the righthand bargraph.

**Example:** :SENS1:POW:REFL:RANG:LIM:DET INB \*RST value: HIGH

**:SENSe<n>:POWER:REFlection:RANGe:LOWer** -1999.0..+1999.0|MINimum|MAXimum|DEFAULT

This command defines the lower scale limit for the righthand bargraph (reflection indication). Since the entry is made without unit, the following should be observed:

- The meaning of the entered numeric value depends on the display mode selected. The value 1.0 may mean matching (SWR indication) or total mismatch (indication of reflection coefficient).
- The entered numeric value remains the same when another display mode is selected (SWR, return loss, reflection coefficient or reverse power) so that a change of the display mode also changes the meaning of the scale limit.
- For the entered scale limit to become effective, the automatic scaling of the bargraph has to be switched off. The following commands set the lower scale limit to an SWR of 1.0:

**Example:** :SENS1:POW:REFL:RANG:AUTO OFF  
 :SENS1:POW:REFL:RANG:LOW 1.0 \*RST value: 0.00  
 :SENS1:FUNC "POW:REFL"  
 :UNIT1:POW:REFL SWR

**:SENSe<n>:POWER:REFlection:RANGe[:UPPer]** -1999.0..+1999.0|MINimum|MAXimum|DEFAULT

This command defines the upper scale limit for the righthand bargraph (reflection indication). The entry is made without unit. For further details see above (entry of lower scale limit).

The following commands set the upper scale limit to a reverse power of 100 W:

**Example:** :SENS1:POW:REFL:RANG:AUTO OFF  
 :SENS1:POW:REFL:RANG 100 \*RST value: 1.0  
 :SENS1:FUNC "POW:REV"  
 :UNIT1:POW W

**:SENSe<n>:SWR**

The NRT offers the possibility of monitoring the load matching and giving an acoustic alarm in case of high mismatch. The commands under this node are used to define the limit value for the SWR and the response threshold for the forward power.

**:SENSe<n>:SWR:LIMit** 1 to 100 | MINimum | MAXimum | DEFault

This command sets the limit value for the SWR at which an alarm is triggered. For an alarm signal to be output the forward power must also exceed a preset threshold (THReshold - see following command).

**Example:** :SENS1:SWR:LIM 1.5 \*RST value: 3.0

**:SENSe<n>:SWR:THReshold** 0 to 100E6 W | -200 to 200dBm | MINimum | MAXimum | DEFault

This command sets a threshold for the forward power, below which no automatic alarm is given even if the SWR limit value has been exceeded (see previous command). The entry is made in the units W or dBm.

**Example:** :SENS:SWR:LIM 15 \*RST value: 100 MW

**:SENSe<n>:SWR:SIGNal** NONE | BEEPPer | TTLSignal | BOTH

This command controls the output of the SWR alarm: The setting BEEPPer generates an acoustic output, TTLSignal outputs an electrical signal via rear-panel connector AUX TTL, BOTH an acoustic and electrical alarm. The settings available with this command have to be made via the UTIL-AUX/IO and UTIL-BEEPER menus in manual operation. If an electrical signal is output via the AUX TTL connector, the other function of this connector has to be deactivated beforehand (see example in section 2.5.9.3).

**Examples:** see sections 2.5.9.3 and 2.5.7 \*RST value: BEEPPer

**:SENSe<n>:SWR:SIGNal[:TTLSignal]:LEVel** LOW | HIGH

This command is used to define the logic level of the SWR alarm at the AUX TTL connector.

**Examples:** :SENS1:SWR:SIGN:LEV HIGH \*RST value: HIGH

### 3.5.12 STATus Subsystem

This subsystem contains the commands for the Status Reporting System (see Section 3.7). A reset of the instrument (\*RST) has no effect on the status registers.

**Table 3-10 STATus subsystem**

Command	Parameter	Unit	Notes
<b>:STATus</b>			
<b>OPERation</b>			
[:EVENT]?			Query only
:CONDition?			Query only
:PTRansition	0 to 32767		
:NTRansition	0 to 32767		
:ENABLE	0 to 32767		
:PRESet			
<b>QUESTionable</b>			
[:EVENT]?			Query only
:CONDition?			Query only
:PTRansition	0 to 32767		
:NTRansition	0 to 32767		
:ENABLE	0 to 32767		
:QUEue			
[:NEXT]?			Query only

**:STATus:OPERation[:EVENT]?**

This query returns the contents of the EVENT register of the STATus:OPERation register. Reading the EVENT register clears it.

**Example:**   :STAT:OPER:EVEN?

**:STATus:OPERation:CONDition?**

This query returns the contents of the CONDition register of the STATus:OPERation register. Reading the CONDition register is nondestructive. The returned value directly reflects the current hardware status.

**Example:**   :STAT:OPER:COND?

**:STATus:OPERation:PTRansition 0 to 32767**

This command (Positive Transition) sets the positive transition filters of all bits of the STATus:OPERation register for the transitions of the CONDition bits from 0 to 1.

**Example:**   :STAT:OPER:PTR 32767

**:STATus:OPERation:NTRansition 0 to 32767**

This command (Negative Transition) sets the negative transition filters of all bits of the STATus:OPERation register for the transitions of the CONDition bits from 1 to 0.

**Example:**   :STAT:OPER:NTR 0

**:STATus:OPERation:ENABLE 0 to 32767**

This command sets the bits of the ENABLE register. This register selects and enables the individual events of the associated status event register for the summary bit in the status byte.

**Example:** :STAT:OPER:ENAB 1

**:STATus:PRESet**

This command resets the transition filters and ENABLE registers of all registers to a defined value. All PTRansition filters are set to FFFFh, ie all transitions from 0 to 1 are detected. All NTRansition filters are set to 0, ie a transition from 1 to 0 in a CONDition bit is not detected. The ENABLE registers of the STATus:OPERation and STATus:QUEStionable registers are set to 0, ie all events in these registers will not be reported further.

**Example:** :STAT:PRES

**:STATus:QUEStionable[:EVENT]?**

This query returns the contents of the EVENT register of the STATus:QUEStionable register. Reading the EVENT register clears it.

**Example:** :STAT:QUES:EVENT?

**:STATus:QUEStionable:CONDition?**

This query returns the contents of the CONDition register of the STATus:QUEStionable register. Reading the CONDition register is nondestructive. The returned value directly reflects the current hardware status.

**Example:** :STAT:QUES:COND?

**:STATus:QUEStionable:PTRansition 0 to 32767**

This command (Positive Transition) sets the positive transition filters of all bits of the STATus:QUEStionable register for the transitions of the CONDition bits from 0 to 1.

**Example:** :STAT:QUES:PTR 32767

**:STATus:QUEStionable:NTRansition 0 to 32767**

This command (Negative Transition) sets the negative transition filters of all bits of the STATus:QUEStionable register for the transitions of the CONDition bits from 1 to 0.

**Example:** :STAT:QUES:NTR 0

**:STATus:QUEStionable:ENABLE 0 to 32767**

This command sets the bits of the ENABLE register. This register selects and enable the individual events of the associated status event register for the summary bit in the status byte.

**Example:** :STAT:QUES:ENAB 1

**:STATus:QUEue[:NEXT]?**

This query returns the next item from the error queue and removes that item from the queue. Positive error numbers denote device-specific errors, negative error numbers denote the error messages defined by SCPI (see Appendix B, List of Error Messages). If the queue is empty, the NRT returns 0, ie "No error". Operation is identical to that of SYSTem:ERRor?.

**Example:** :STAT:QUE? Response: -221, "Settings conflict"

### 3.5.13 SYSTem Subsystem

This subsystem provides a number of commands for general functions, which are not directly related to the measurement functions.

**Table 3-11 SYSTem subsystem**

Command	Parameter	Unit	Notes
:BEEPer			
:STATe	ON   OFF		
:COMMunicate			
:GPIB			
[:SELf]			
:ADDRes	0 to 30		
:SERial			
[:RECeive]			
:BAUD	1200   2400   4800   9600   19200   MINimum   MAXimum   DEFault	Baud	
:PACE	XON   NONE		
:CONTRol			
:RTS	OFF   BFULL   RFR		
:ERRor?			Query only
:PRESet			No query
:VERSion?			Query only

**:SYSTem:BEEPer:STATe ON | OFF**

This command switches the beeper on or off.

**Example:** :SYST:BEEP:STAT ON

\*RST value: OFF

**:SYSTem:COMMunicate**

This node provides the commands for setting the remote-control channels.

**:SYSTem:COMMunicate:GPIB**

This node provides the commands for checking the IEC/IEEE bus (GPIB = General Purpose Interface Bus)

**:SYSTem:COMMunicate:GPIB[:SELf]:ADDRes 0 to 30**

This command sets the IEC/IEEE-bus device address.

**Example:** :SYST:COMM:GPIB:ADDR 1

\*RST value: none (last setting)





### 3.5.14 TEST Subsystem

This subsystem provides selftest functions for the NRT basic unit. Moreover it directly transfers unfiltered setting commands to the sensor. The NRT serves as a transfer unit.

**Table 3-12 TEST subsystem**

Command	Parameter	Unit	Notes
:TEST			
ROM?			Query only
RAM?			Query only
FRAM?			Query only
[:ALL]?			Query only
:DIRect[?]	"Sensor command"		Transfer to sensor no query
:SENSor?			Query only

All test functions except :TEST:DIRect either return 0 or 1, with 0 standing for "no error" and 1 for "error"

#### :TEST:ROM?

The command tests the program ROM. This command is a query and therefore has no \*RST value.

**Example:** :TEST:ROM? Response: 0

#### :TEST:RAM?

The command tests the RAM. This command is a query and therefore has no \*RST value.

**Example:** :TEST:RAM? Response: 0

#### :TEST:FRAM?

The command tests the parameter memory. This command is a query and therefore has no \*RST value.

**Example:** :TEST:FRAM? Response: 0

#### :TEST[:ALL]?

The command tests all memories of the instrument. This command is a query and therefore has no \*RST value.

**Example:** :TEST? Response: 0

**:TEST:DIRect[?] "Sensor command"**

This command is used for transferring direct setting commands to the active sensor. The setting commands are contained in the sensor manual. With a ? appended, the command returns the response of the sensor to the transferred command. This command has no \*RST value.

**Example:** :TEST:DIR "sensor command"

**:TEST:SENSor?**

This command returns the status of the active sensor.

**Example:** :TEST:SENS ?

The response is sensor-dependent and could read as follows:

"NRT-Z44 V1.40","TEMPERATURE ERR", "CAL VALUES CHECKSUM ERR"

The response always contains an identification string for the sensor with the type name and the FW version number. In case of an error, error messages in plain text are appended. The content of the response string is identical with the status query in manual control (see Section 2.5.11).

### 3.5.15 TRIGger Subsystem

The TRIGger subsystem synchronizes device actions and measurements with certain defined events. Moreover the subsystem sends a cyclical record of the measurement results to an external device and thus provides logging of a complete measurement sequence.

**Table 3-13 TRIGger subsystem**

Command	Parameter	Unit	Notes
:TRIGger [:TRIGger][:IMMediate]	INTernal   EXTernal		No query

#### :TRIGger[:TRIGger]

This node contains the commands for specific triggering of individual measurements.

#### :TRIGger[:TRIGger][:IMMediate]

This command triggers a measurement. The result must be queried with the command :SENS<n>:DATA?. See chapter 3.5.2, Trigger and Measurement during Remote Control.

**Example:** :TRIG

#### :TRIGger[:TRIGger]:SOURce INTernal | EXTernal

This command sets the trigger source for all the following measurements.

**INTernal** The internal timer is used as a trigger source. As a result, the measurement is performed in the freerun mode. This implies that the sensor carries out measurements permanently but that they are not related to the test signal. The NRT provides the last measured value upon a query command :SENSe<n>:DATA...

**EXTernal** This mode allows to trigger measurements via the two remote control interfaces (commands :TRIG and \*TRG) or the AUX TTL connector at the rear panel of the device. The event which arrives first is used for triggering. The measurement is triggered immediately after the trigger event arrives. The measured quantity may change before triggering starts but should then remain unchanged until the end of the measurement.

**Note:** *The trigger command :TRIG:SOUR EXT acts as if the AUX TTL connector was switched to the EXT.TRIG state via the UTILity menu. The AUX TTL connector can not be used as a monitoring connector if this setting is active.*

**Example:** see section 2.5.9

\*RST value: INT

### 3.5.16 UNIT Subsystem

The UNIT subsystem defines the units for the power and reflection indication in the selected measurement channel (suffix <n>).

**Table 3-14 UNIT subsystem**

Command	Parameter	Unit	Notes
:UNIT<n> :POWer :RELative :STATe :REFlection	W   DBM PCT   DB ON   OFF RCO   RL   SWR   RFR		

**Note:** *The results of the <Measurement Function> **POW:CFAC** are always in units of dB, the results of **POW:FORW:CCDF** always in %.*

#### :UNIT<n>:POWer W | DBM

This command defines the unit for the forward power (FWD), absorbed power (F-R) and reverse power (REV). For the setting to become effective, the relative display must be switched off (see command :UNIT<n>:POWer:RELative: STATe OFF further below).

W power (in W)  
DBM power level (in dBm)

**Example:** :UNIT0:POW:REL:STAT OFF  
:UNIT0:POW DBM \*RST value: W

#### :UNIT<n>:POWer:RELative PCT | DB

This command allows the forward power (FWD) and the absorbed power (F-R) to be indicated in relative display mode. For the setting to become effective, the relative display mode must be switched on (see command :UNIT<n>:POWer:RELative: STATe ON further below).

PCT deviation from reference value in percent  
DB deviation from reference value in dB

**Example:** :UNIT2:POW:REL:STAT ON  
:UNIT2:POW:REL DB \*RST value: PCT

#### :UNIT<n>:POWer:RELative:STATe ON | OFF

This command defines the indication of the forward power (FWD), reverse power (REV) and absorbed power (F-R) in absolute units (W, dBm) or in relative display mode (% , dB). "ON" switches the relative display mode on and the absolute display off. "OFF" has the opposite effect.

**Example:** :UNIT1:POW:REL:STAT ON \*RST value: OFF

**:UNIT<n>:POWer:REFLection** RCO | RTL | SWR | RFR

This command defines the matching of the load being measured as standing wave ratio, return loss, reflection coefficient, or power ratio R/F (in percent).

SWR        standing wave ratio (1 to  $\infty$ ; without unit)  
RL         return loss (in dB)  
RCO        reflection coefficient (0 to 1; without unit)  
RFR        Ratio between forward and reverse power (0% to 100%)

**Note:**        *This command is only effective if the measurement function **POW:S11** or **POW:REFL** (see **SENSe<n>:FUNC** subsystem) has been activated.*

**Example:**    :SENSe1:FUNC "POW:REFL"  
              :UNIT1:POW:REFL RCO

\*RST value: SWR

### 3.6 Instrument Model and Command Processing

The block diagram in figure Fig. 3-2 shows how IEC/IEEE-bus commands are serviced in the instrument. The individual components work independently and simultaneously. They communicate with each other by means of so-called "messages".

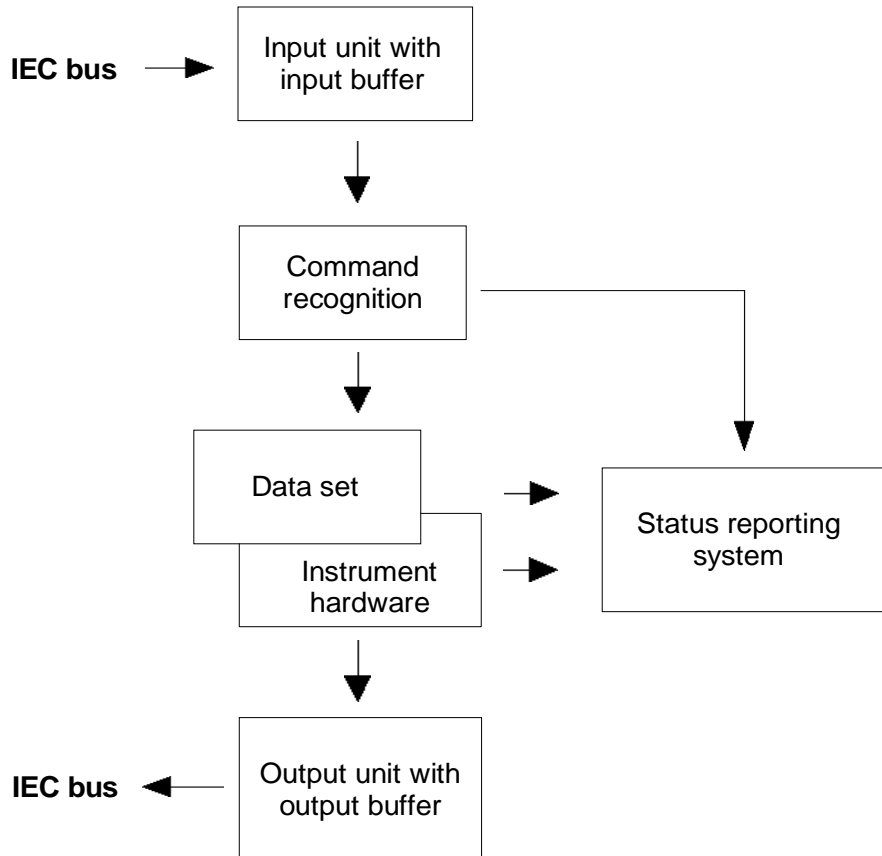

Fig. 3-2 Instrument model in the case of remote control by means of the IEC bus

#### 3.6.1 Input Unit

The input unit receives commands character by character from the IEC bus and collects them in the input buffer. The input unit sends a message to the command recognition as soon as the input buffer is full or as soon as it receives a delimiter, <PROGRAM MESSAGE TERMINATOR>, as defined in IEEE 488.2, or the interface message DCL.

If the input buffer is full, the IEC/IEEE-bus traffic is stopped and the data received up to then are processed. Subsequently the IEC/IEEE-bus traffic is continued. If, however, the buffer is not yet full when receiving the delimiter, the input unit can already receive the next command during command recognition and execution. The receipt of a DCL clears the input buffer and immediately initiates a message to the command recognition.

### **3.6.2 Command Recognition**

The command recognition analyses the data received from the input unit. It proceeds in the order in which it receives the data. Only a DCL is serviced with priority, a GET (Group Execute Trigger), e.g., is only executed after the commands received before. Each recognized command is immediately transmitted to the data set but not executed immediately.

Syntactical errors in the command are recognized here and transferred to the status reporting system. The rest of a command line after a syntax error is analyzed further as far as possible and serviced.

If the command recognition recognizes a delimiter or a DCL, it requests the data set to set the commands in the instrument hardware as well. Subsequently it is immediately prepared to process commands again. This means for the command servicing that further commands can already be serviced while the hardware is still being set ("overlapping execution").

### **3.6.3 Data Set and Instrument Hardware**

The expression "instrument hardware" denotes the part of the instrument fulfilling the actual instrument function - signal generation, measurement etc. The controller is not included.

The data set is a detailed software reproduction of the instrument hardware.

IEC/IEEE-bus setting commands lead to an alteration in the data set. The data set management enters the new values (e.g. frequency) into the data set, however, only passes them on to the hardware when requested by the command recognition. As this is always only effected at the end of a command line, the order of the setting commands in the command line is not relevant.

The data are only checked for their compatibility among each other and with the instrument hardware immediately before they are transmitted to the instrument hardware. If the detection is made that execution is not possible, an "execution error" is signaled to the status reporting system. All alterations of the data set are canceled, the instrument hardware is not reset. Due to the delayed checking and hardware setting, however, impermissible instrument states can be set for a short period of time within one command line without this leading to an error message (example: simultaneous activation of FM and PM). At the end of the command line, however, a permissible instrument state must have been reached again.

Before passing on the data to the hardware, the settling bit in the STATus:OPERation register is set (cf. Section 3.7.3.4). The hardware executes the settings and resets the bit again as soon as the new state has settled. This fact can be used to synchronize command servicing.

IEC/IEEE-bus queries induce the data set management to send the desired data to the output unit.

### **3.6.4 Status Reporting System**

The status reporting system collects information on the instrument state and makes it available to the output unit on request. The exact structure and function are described in Section 3.7, "Status Reporting System".



### 3.6.5 Output Unit

The output unit collects the information requested by the controller, which it receives from the data set management. It processes it according to the SCPI rules and makes it available in the output buffer. If the information requested is longer, it is made available "in portions" without this being recognized by the controller.

If the instrument is addressed as a talker without the output buffer containing data or awaiting data from the data set management, the output unit sends error message "Query UNTERMINATED" to the status reporting system. No data are sent on the IEC bus, the controller waits until it has reached its time limit. This behavior is specified by SCPI.

### 3.6.6 Command Sequence and Command Synchronization

What was said above makes clear that overlapping execution is possible in principle for all commands. Equally, setting commands within one command line are not absolutely serviced in the order in which they have been received.

In order to make sure that commands are actually carried out in a certain order, each command must be sent in a separate command line, that is to say, with a separate IBWRT()-call.

In order to prevent an overlapping execution of commands, one of commands \*OPC, \*OPC? or \*WAI must be used. All three commands cause a certain action only to be carried out after the hardware has been set and has settled. By a suitable programming, the controller can be forced to wait for the respective action to occur (cf. Table 3-15).

**Table 3-15 Synchronization with \*OPC, \*OPC? and \*WAI**

Com- mand	Action after the hardware has settled	Programming the controller
*OPC	Setting the operation-complete bit in the ESR	- Setting bit 0 in the ESE - Setting bit 5 in the SRE - Waiting for service request (SRQ)
*OPC?	Writing a "1" into the output buffer	Addressing the instrument as a talker
*WAI	Executing the next command Note: The IEC/IEEE-bus handshake is not stopped	Sending the next command

An example for command synchronization can be found in Annex D, "Programming Examples".

### 3.7 Status Reporting System

The status reporting system (cf. Fig. 3-4) stores all information on the present operating state of the instrument, e.g. that the instrument presently carries out an AUTORANGE and on errors which have occurred. This information is stored in the status registers and in the error queue. The status registers and the error queue can be queried via IEC bus.

The information is of a hierarchical structure. The register status byte (STB) defined in IEEE 488.2 and its associated mask register service request enable (SRE) form the uppermost level. The STB receives its information from the standard event status register (ESR) which is also defined in IEEE 488.2 with the associated mask register standard event status enable (ESE) and registers STATUS:OPERation and STATUS:QUESTionable which are defined by SCPI and contain detailed information on the instrument.

The IST flag ("Individual Status") and the parallel poll enable register (PPE) allocated to it are also part of the status reporting system. The IST flag, like the SRQ, combines the entire instrument status in a single bit. The PPE fulfills an analog function for the IST flag as the SRE for the service request.

The output buffer contains the messages the instrument returns to the controller. It is not part of the status reporting system but determines the value of the MAV bit in the STB and thus is represented in Fig. 3-4.

#### 3.7.1 Structure of an SCPI Status Register

Each SCPI register consists of 5 parts which each have a width of 16 bits and have different functions (cf. Fig. 3-3). The individual bits are independent of each other, i.e. each hardware status is assigned a bit number which is valid for all five parts. For example, bit 3 of the STATUS:OPERation register is assigned to the hardware status "wait for trigger" in all five parts. Bit 15 (the most significant bit) is set to zero for all parts. Thus the contents of the register parts can be processed by the controller as positive integer.

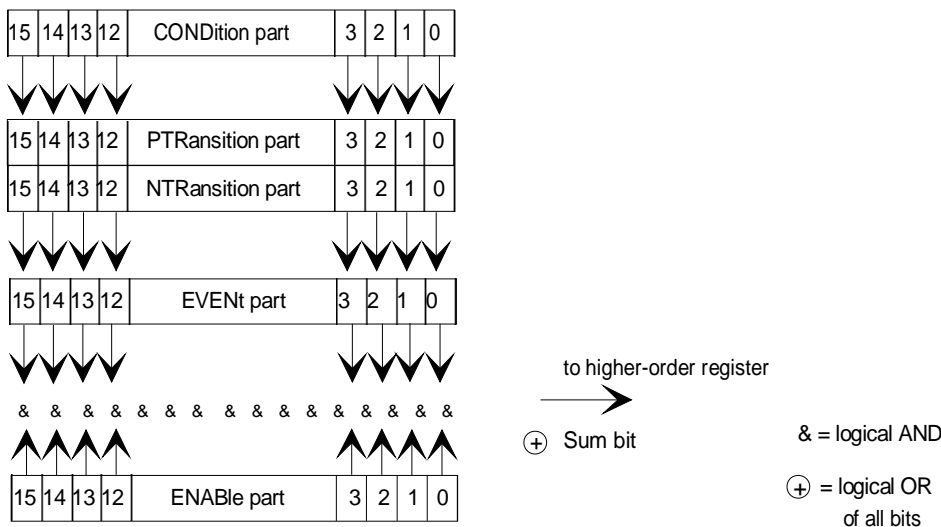

Fig. 3-3 The status register model

<b>CONDition part</b>	The CONDition part is directly written into by the hardware or the sum bit of the next lower register. Its contents reflects the current instrument status. This register part can only be read, but not written into or cleared. Its contents is not affected by reading.
<b>PTRansition part</b>	The <u>P</u> ositive- <u>T</u> Ransition part acts as an edge detector. When a bit of the CONDition part is changed from 0 to 1, the associated PTR bit decides whether the EVENT bit is set to 1. PTR bit =1: the EVENT bit is set. PTR bit =0: the EVENT bit is not set. This part can be written into and read at will. Its contents is not affected by reading.
<b>NTRansition part</b>	The <u>N</u> egative- <u>T</u> Ransition part also acts as an edge detector. When a bit of the CONDition part is changed from 1 to 0, the associated NTR bit decides whether the EVENT bit is set to 1. NTR bit =1: the EVENT bit is set. NTR bit =0: the EVENT bit is not set. This part can be written into and read at will. Its contents is not affected by reading.  With these two edge register parts the user can define which state transition of the condition part (none, 0 to 1, 1 to 0 or both) is stored in the EVENT part.
<b>EVENT part</b>	The EVENT part indicates whether an event has occurred since the last reading, it is the "memory" of the condition part. It only indicates events passed on by the edge filters. It is permanently updated by the instrument. This part can only be read by the user. Upon reading, its contents is set to zero. In colloquial language, this part is often equated with the entire register.
<b>ENABLE part</b>	The ENABLE part determines whether the associated EVENT bit contributes to the sum bit (cf. below). Each bit of the EVENT part is ANDed with the associated ENABLE bit (symbol '&'). The results of all logical operations of this part are passed on to the sum bit via an OR function (symbol '+'). ENAB bit =0: the associated EVENT bit does not contribute to the sum bit ENAB bit =1: if the associated EVENT bit is "1", the sum bit is set to "1" as well. This part can be written into and read by the user at will. Its contents is not affected by reading.
<b>Sum bit</b>	As indicated above, the sum bit is obtained from the EVENT and ENABLE part for each register. The result is then entered into a bit of the CONDition part of the higher-order register. The instrument automatically generates the sum bit for each register. Thus an event, e.g. a PLL that has not locked, can lead to a service request throughout all levels of the hierarchy.
<b>Note:</b>	<i>The service request enable register SRE defined in IEEE 488.2 can be taken as ENABLE part of the STB if the STB is structured according to SCPI. By analogy, the ESE can be taken as the ENABLE part of the ESR.</i>



### 3.7.3 Description of the Status Registers

#### 3.7.3.1 Status Byte (STB) and Service Request Enable Register (SRE)

The STB is already defined in IEEE 488.2. It provides a rough overview of the instrument status by collecting the pieces of information of the lower registers. It can thus be compared with the CONDition part of an SCPI register and assumes the highest level within the SCPI hierarchy. A special feature is that bit 6 acts as the sum bit of the remaining bits of the status byte.

The STATUS BYTE is read out using the command "\*STB?" or a serial poll.

The STB is linked to the SRE. The latter corresponds to the ENABLE part of the SCPI registers in its function. Each bit of the STB is assigned a bit in the SRE. Bit 6 of the SRE is ignored. If a bit is set in the SRE and the associated bit in the STB changes from 0 to 1, a Service Request (SRQ) is generated on the IEC bus, which triggers an interrupt in the controller if this is appropriately configured and can be further processed there.

The SRE can be set using command "\*SRE" and read using "\*SRE?".

**Table 3-16 Meaning of the bits used in the status byte**

Bit no.	Meaning
2	<p><b>Error Queue not empty</b></p> <p>The bit is set when an entry is made in the error queue. If this bit is enabled by the SRE, each entry of the error queue generates a Service Request. Thus an error can be recognized and specified in greater detail by polling the error queue. The poll provides an informative error message. This procedure is to be recommended since it considerably reduces the problems involved with IEC/IEEE-bus control.</p>
3	<p><b>QUESTIONable status sum bit</b></p> <p>The bit is set if an EVENT bit is set in the QUESTIONable status register and the associated ENABLE bit is set to 1. A set bit indicates a questionable instrument status, which can be specified in greater detail by polling the QUESTIONable status register.</p>
4	<p><b>MAV-Bit (Message Available)</b></p> <p>The bit is set if a message is available in the output buffer which can be read. This bit can be used to enable data to be automatically read from the instrument to the controller (cf. annex D, program examples).</p>
5	<p><b>ESB bit</b></p> <p>Sum bit of the event status register. It is set if one of the bits in the event status register is set and enabled in the event status enable register. Setting of this bit indicates a serious error which can be specified in greater detail by polling the event status register.</p>
6	<p><b>MSS-Bit (Master Status Summary bit)</b></p> <p>The bit is set if the instrument triggers a service request. This is the case if one of the other bits of this register is set together with its mask bit in the service request enable register SRE.</p>
7	<p><b>OPERation status register sum bit</b></p> <p>The bit is set if an EVENT bit is set in the OPERation status register and the associated ENABLE bit is set to 1. A set bit indicates that the instrument is just performing an action. The type of action can be queried by polling the OPERation status register.</p>

### 3.7.3.2 IST Flag and Parallel Poll Enable Register (PPE)

By analogy with the SRQ, the IST flag combines the entire status information in a single bit. It can be queried by means of a parallel poll (cf. Section 3.7.4.3, "Parallel Poll") or using the command "\*IST?".

The parallel poll enable register (PPE) determines which bits of the STB contribute to the IST flag. The bits of the STB are ANDed with the corresponding bits of the PPE, with bit 6 being used as well in contrast to the SRE. The IST flag results from the ORing of all results. The PPE can be set using commands "\*PRE" and read using command "\*PRE?".

### 3.7.3.3 Event Status Register (ESR) and Event Status Enable Register (ESE)

The ESR is already defined in IEEE 488.2. It can be compared with the EVENT part of an SCPI register. The event status register can be read out using command "\*ESR?".

The ESE is the associated ENABLE part. It can be set using the command "\*ESE" and read using the command "\*ESE?".

**Table 3-17 Meaning of the bits used in the event status register**

Bit No.	Meaning
0	<b>Operation Complete</b> This bit is set on receipt of the command *OPC exactly when all previous commands have been executed.
2	<b>Query Error</b> This bit is set if either the controller wants to read data from the instrument without having sent a query, or if it does not fetch requested data and sends new instructions to the instrument instead. The cause is often a query which is faulty and hence cannot be executed.
3	<b>Device-dependent Error</b> This bit is set if a device-dependent error occurs. An error message with a number between -300 and -399 or a positive error number, which denotes the error in greater detail, is entered into the error queue (cf. annex B, Error Messages).
4	<b>Execution Error</b> This bit is set if a received command is syntactically correct but cannot be performed for other reasons. An error message with a number between -200 and -300, which denotes the error in greater detail, is entered into the error queue (cf. annex B, Error Messages).
5	<b>Command Error</b> This bit is set if a command which is undefined or syntactically incorrect is received. An error message with a number between -100 and -200, which denotes the error in greater detail, is entered into the error queue (cf. annex B, Error Messages).
6	<b>User Request</b> This bit is set on pressing the  key, i.e., when the instrument is switched over to manual control.
7	<b>Power On</b> (supply voltage on) This bit is set on switching on the instrument.

### 3.7.3.4 STATUS:OPERation Register

In the CONDition part, this register contains information on which actions the instrument is being executing or, in the EVENt part, information on which actions the instrument has executed since the last reading. It can be read using one of the commands "STATus:OPERation:CONDition?" or "STATus:OPERation [:EVENT]?"

**Table 3-18 Meaning of the bits used in the STATus:OPERation register**

Bit-No.	Meaning
1	<b>SETTing</b> This bit is set when the sensor is initialized.
4	<b>MEASuring</b> This bit is set while the instrument is performing a measurement.
5	<b>Waiting for TRIGGER</b> This bit is set as long as the instrument is waiting for a trigger event.
8	<b>BOPeration</b> This bit is set in the case of battery operation.
9	<b>CALCulating</b> This bit is set when the instrument performs a limit check.

### 3.7.3.5 STATUS:QUEStionable Register

This register contains information on questionable instrument states. They can occur, e.g. if the instrument is operated outside its specified range. It can be queried using one of the commands ":STATus:QUEStionable:CONDition?" or ":STATus:QUEStionable[:EVENT]?".

**Table 3-19 Meaning of the bits used in the STATus:QUEStionable register**

Bit-No.	Meaning
3	<b>POWer</b> This bit is set if one on the following conditions is fulfilled: <ul style="list-style-type: none"> <li>• Sensor overload: The forward or reverse power exceeds the maximum values specified for the sensor.</li> <li>• Power control: The measured values for power or matching exceed the limit values for the corresponding bar graphs and the control function over the AUX TTL socket is active.</li> <li>• Power supply: The central supply voltage for sensor and basic instrument exceeds/falls below the allowed limits.</li> </ul>
9	<b>SINFinite</b> Setting this bit corresponds to the acoustic message sent when the SWR or forward power threshold is exceeded.

Bit-No.	Meaning
10	<p><b>SERRor</b></p> <p>This bit is set when the sensor signals an exceptional situation.</p> <p><b>Example:</b> The sensor is operated outside its allowed temperature range.</p>
11	<p><b>ABURst</b></p> <p>This bit is set in the case of conflicting burst parameters (the burst period set is smaller than the burst width). The NRT then returns measured results corresponding to the unmodulated signal.</p>

### 3.7.4 Application of the Status Reporting Systems

In order to effectively use the status reporting system, the information contained there must be transmitted to the controller and further processed there. There are several methods which are outlined in the following. For detailed program examples, see Annex D, "Programming Examples".

#### 3.7.4.1 Service Request, Making Use of the Hierarchy Structure

Under certain circumstances, the instrument can send a service request (SRQ) to the controller. Usually this service request initiates an interrupt at the controller, to which the control program can react appropriately. As evident from Fig. 3-4 (Section 3.7.2), an SRQ is always initiated if one or several of bits 2, 3, 4, 5 or 7 of the status byte are set and enabled in the SRE. Each of these bits combines the information of a further register, the error queue or the output buffer. The corresponding setting of the ENABLE parts of the status registers can achieve that arbitrary bits in an arbitrary status register initiate an SRQ. In order use the possibilities of the service request effectively, all bits should be set to "1" in the enable registers SRE and ESE.

Examples (cf. Fig. 3-4, Section 3.7.2 and Annex D, "Programming examples"):

Use command `*OPC` to generate an SRQ

- Set bit 0 in the ESE (Operation Complete)
  - Set bit 5 in the SRE (ESB)
- After its settings have been completed, the instrument generates an SRQ.

Indication of the end of a measurement by means of an SRQ with the controller

- Set bit 7 in the SRE (sum bit of the STATus:OPERation register)
- Set bit 4 (measuring) in the STATus:OPERation:ENABLE.
- Set bit 4 in the STATus:OPERation:NTRansition so as to make sure that the transition of measuring bit 4 from 1 to 0 (end of measurement) is recorded in the EVENT part.

After a sweep has been completed, the instrument generates an SRQ.

The SRQ is the only possibility for the instrument to become active on its own. Each controller program should set the instrument such that a service request is initiated in the case of malfunction. The program should react appropriately to the service request. A detailed example for a service request routine can be found in Annex D, "Programming examples".



### 3.7.4.2 Serial Poll

In a serial poll, just as upon the command "`*STB`", the status byte of an instrument is queried. However, the query is made via interface messages and is thus clearly faster. The serial-poll method has already been defined in IEEE 488.1 and used to be the only standard possibility for different instruments to poll the status byte. The method also works for instruments which do not adhere to SCPI or IEEE 488.2.

The quick-BASIC command for executing a serial poll is "`IBRSP()`". The serial poll is mainly used to obtain a fast overview of the state of several instruments connected to the IEC bus.

### 3.7.4.3 Parallel Poll

In a parallel poll, up to eight instruments are simultaneously requested by the controller by means of a single command to transmit 1 bit of information each on the data lines, i.e., to set the data line allocated to each instrument to a logic "0" or "1". By analogy to the SRE register which determines under which conditions an SRQ is generated, there is a parallel poll enable register (PPE) which is ANDed with the STB bit by bit, considering bit 6 – AND as well. The results are ORed, the result is then sent (possibly inverted) as a response to the parallel poll of the controller. The result can also be queried without parallel poll by means of the command "`*IST`".

The instrument first has to be set for the parallel poll using the quick-BASIC command "`IBPPC()`". This command allocates a data line to the instrument and determines whether the response is to be inverted. The parallel poll itself is executed using "`IBRPP()`".

The parallel-poll method is mainly used in order to quickly find out after an SRQ which instrument has sent the service request if there are many instruments connected to the IEC bus. To this effect, SRE and PPE must be set to the same value. A detailed example for a parallel poll can be found in 'Annex D, "Programming Examples".'

### 3.7.4.4 Query by Means of Commands

Each part of any status register can be read by means of queries. The individual commands are listed in the detailed description of the registers in Section 3.7.3. What is returned is always a number which represents the bit pattern of the register queried. Evaluating this number is effected by the controller program.

Queries are usually used after an SRQ in order to obtain more detailed information on the cause of the SRQ.

### 3.7.4.5 Error Queue Query

Each error state in the instrument leads to an entry in the error queue. These entries are detailed plain-text error messages. If a sensor is connected, the errors concerning this sensor can be accessed in manual control via the `UTIL – TEST – SENS` menu. In general, the error queue is queried via the IEC bus using the command "`SYSTem:ERRor?`". Each call of "`SYSTem:ERRor?`" provides one entry from the error queue. If no error messages are stored there any more, the instrument responds with 0, "No error".

The error queue should be queried after every SRQ in the controller program as the entries describe the cause of an error more precisely than the status registers. Especially in the test phase of a controller program the error queue should be queried regularly since faulty commands from the controller to the instrument are recorded there as well.

### 3.7.5 Reset Values of the Status Reporting Systems

Table 3-20 comprises the different commands and events causing the status reporting system to be reset. None of the commands, except for \*RST and SYSTem:PRESet influences the functional instrument settings. In particular, DCL does not change the instrument settings.

**Table 3-20 Resetting instrument functions**

Event	Switching on supply voltage		DCL,SDC (Device Clear, Selected Device Clear)	*RST or SYSTem:PRESet	STATus:PRESet	*CLS
	Power-On-Status-Clear					
	0	1				
Clear STB,ESR	—	yes	—	—	—	yes
Clear SRE,ESE	—	yes	—	—	—	—
Clear PPE	—	yes	—	—	—	—
Clear EVENT parts of the registers	—	yes	—	—	—	yes
Clear ENABLE parts of all OPERATION-and QUESTIONable registers, Fill ENABLE parts of all other registers with "1".	—	yes	—	—	yes	—
Fill PTRansition parts with "1" Clear NTRansition parts	—	yes	—	—	yes	—
Clear error queue	yes	yes	—	—	—	yes
Clear output buffer	yes	yes	yes	1)	1)	1)
Clear command processing and input buffer	yes	yes	yes	—	—	—

1) Every command being the first in a command line, i.e. immediately following a <PROGRAM MESSAGE TERMINATOR> clears the output buffer.

## 4 Maintenance and Troubleshooting

### 4.1 Maintenance

Under normal operating conditions, no regular maintenance is required except for occasional cleaning of the front panel and replacement of the battery (option NRT-B3).

#### 4.1.1 Cleaning the Outside

For cleaning the outside of the instrument it is recommended to use a soft, lint-free cloth and a non-alcoholic solvent, eg a commercial detergent.

**Note:** *In no case use solvents such as nitro thinners, acetone or similar, since these may damage the front-panel labels or plastic parts.*

#### 4.1.2 Replacing the Battery (Option NRT-B3)

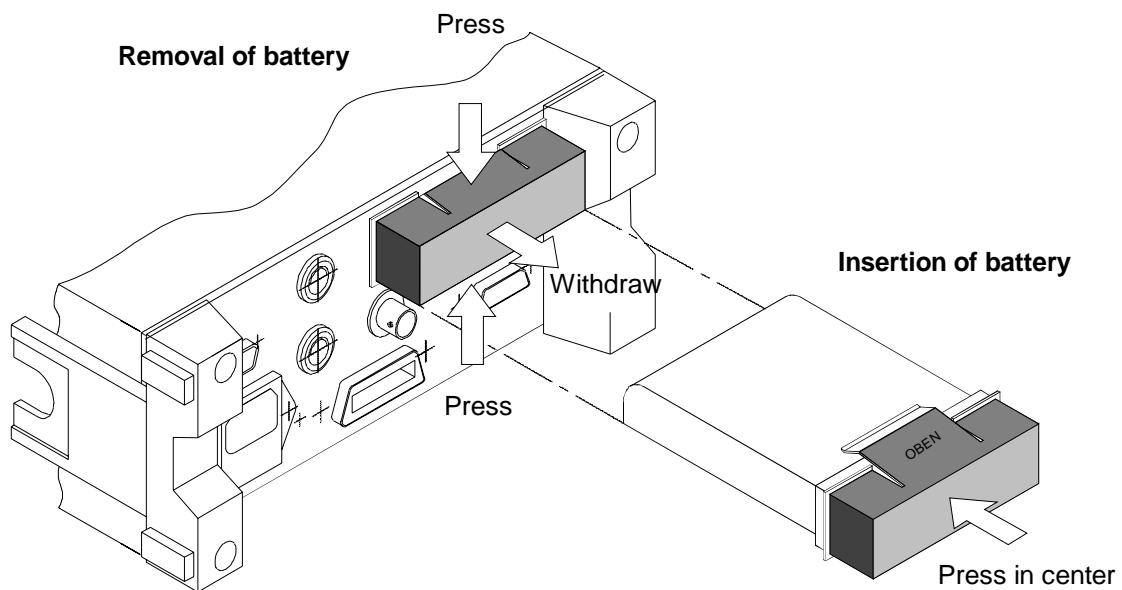

**Fig. 4-1** Insertion and removal of battery

The NiMH battery used in the NRT is a high-performance battery with a lifetime of typically more than 200 charge/discharge cycles.

The battery should be replaced if the operating time with a Sensor NRT-Z44 is less than 4 hours. Spare batteries are available from Rohde & Schwarz under the designation NRT-Z1 (Order No. 1081.1209.02). The battery comes complete with the plastic cap used as a holder.

For batteries from the manufacturer FEDCO (type designation ENERGY+ DR30AA), the plastic cap of the old battery has to be used (carefully lift the locking flaps when removing it).

**Note:** To replace the battery, the instrument need not be opened. The battery is accessible from the rear panel (see Fig. 4-1, Rear view).

**Caution:**

Avoid short-circuiting of the metal contacts of the battery under all circumstances. Only use type NRT-Z1 (ENERGY+ DR30AA) batteries.

**Removing the battery**

Press together the plastic cap and withdraw the battery.

**Inserting the battery**

Insert the battery into the battery compartment on the rear panel with the marking TOP pointing upwards.

Wrong insertion of the battery and hence wrong polarity is prevented by mechanical coding of the battery contacts.

**Disposal**

Return used up batteries to the dealer or dispose them as hazardous waste. Do not throw them into the domestic waste or fire.

**Charging**

NiMH batteries reach their full capacity only after 5 to 10 charge cycles. If a new battery has been inserted into the NRT, it should therefore be fully discharged and recharged several times. Charging is usually started automatically if the NRT is connected to the AC supply after at least three hours battery operation time.

Charging is always indicated by the danger arrow symbol above the battery symbol lighting up. Charging of a fully discharged battery should be completed after max. 2.5 hours (danger arrow symbol disappears). Although all important parameters, including the battery temperature, are continuously monitored during charging, please observe the following:

**Caution:**

Immediately disconnect the power plug if there are signs of battery overheating (smoke or smell).

**Note:** Avoid charging at ambient temperatures below 0°C or above 45°C.  
Avoid charging of cold battery (< 0°C).

Occasional charging of partly discharged batteries does not cause any damage. Repeated charging of fully charged batteries should be avoided. Since it takes some time to detect the fully charged state, there will be an overcharge during this time which will reduce the battery life.

### 4.1.3 Storage

The storage temperature range of the NRT is -40°C to +70°C.

If the instrument with the battery option NRT-B3 is to be stored for a longer period, the battery should be removed as described in Section 4.1.2. To prevent damage due to overdischarging, the batteries should be charged every two to three months.

## 4.2 Firmware Update

### 4.2.1 Loading New Firmware into Basic Unit

Like for many instruments nowadays, a firmware update can also be made for the NRT basic unit via the serial interface. Since it is not necessary to replace an EPROM, the instrument need not be opened.

The NRT is fitted with an RS-232 interface as standard. The 9-pin connector is provided on the rear panel. Using a null modem cable (order no. 1050.0346.029, the NRT can be connected to any PC (386, 486, Pentium).

The characteristics of the serial interface are described in detail in Appendix A, Interfaces. Preparing the null modem cable is also described in detail there. The settings described for the transfer parameters are irrelevant both for the host PC and the target NRT, since for the programming (also referred to as flashup) fixed transfer parameters are set on the NRT and in the flashup programs.

**Note:** *Please note that a successful connection between PC and NRT basic unit can only be established with the aid of a standard null modem cable (see Appendix A, RS-232-C interface). If the cable is not correctly wired, the update may not be correctly performed.*

The firmware for the NRT basic unit is supplied together with the flashup program in the form of a packed, self-extracting archive with the file name NRTxxx.EXE. The string xxx represents the version number of the software.

#### Installing the flashup software on the PC:

- First generate a new, empty directory on drive c:\ :  
(e.g. C:\NRT).
- Copy the file NRTxxx.EXE to directory C:\NRT:
- Next, execute the program file (under DOS or Windows).  
This unpacks the file into the current directory; the installation of the programming software is finished.

The directory ...NRT should now contain the following files in addition to the NRTxxx.EXE file:

FLASHPRO.EXE	MS-DOS program establishing the connection to the target (NRT). It transfers the new program version (NRT.BIN) to the NRT and causes the instrument to load the transferred data as permanent data into the program memory.
NRT.BIN	Binary file containing the firmware to be loaded into the program memory (flash EPROM) of the NRT.
NRT_TRA.BIN	Auxiliary program required for installing the new firmware version and transferred first to the NRT.
NRT40_1.CNF	Configuration file containing all NRT-specific settings for the serial interface COM1 of the PC.
NRT40_2.CNF	Configuration file containing all NRT-specific settings for the serial interface COM2 of the PC.
NRT.TXT	This file is optional. It contains supplements to the manual and a list of the new features and improvements relative to previous firmware versions.

**Loading new firmware into the NRT:**

As a prerequisite the flashup software must have been installed on the PC as described above. Then proceed as follows:

- Switch off the NRT basic unit.
- Connect PC and NRT using the null modem cable.
- Switch on NRT with  key simultaneously pressed.

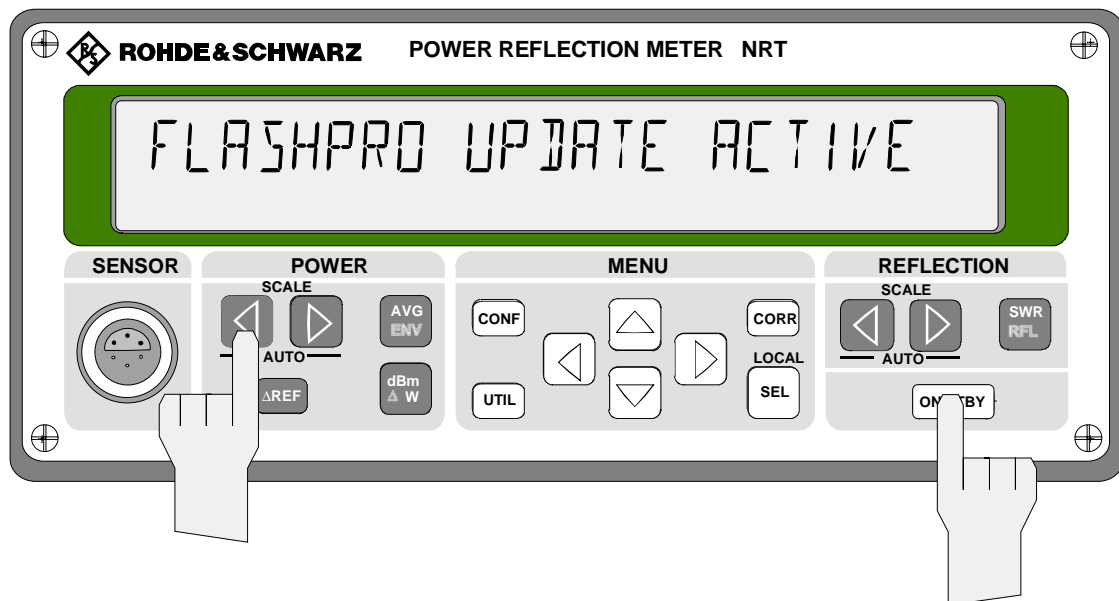

**Fig. 4-2** Switching on the NRT for loading the firmware

FLASHPRO UPDATE ACTIVE should then appear in the display of the NRT (see Fig. 4-2).

- Switch the computer to DOS mode.
- Select root directory c:  
CD \ <Enter> or c: <Enter>
- Select the directory c:\NRT where the flashup software was installed.  
CD NRT <Enter>
- If the cable is connected to interface COM1, start FLASHPRO with the command  
FLASHPRO NRT40\_1.CNF  
The rest of the job is carried out by FLASHPRO without any further action being required.
- If the cable is connected to interface COM2, start FLASHPRO with the command:  
FLASHPRO NRT40\_2.CNF  
The rest of the job is carried out by FLASHPRO without any further action being required.
- Quit DOS mode (under Windows):  
Exit <Enter>

**Note:**

- Do not switch off the NRT basic unit or the PC during programming. Do not interrupt the cable connection during this time either. Otherwise the instrument will not function properly or even crash.
- Should nevertheless the power supply or cable connection be interrupted, restart the programming procedure.

The following messages from FLASHPRO are displayed during programming:

```
R&S FLASHPRO Batchmode V 2.1
```

===== nrt40.cnf =====				
Executing complete programming procedure				
Task	File	Startadr	Length	Progress
-----				
Bootstrap				OK
Transfer	NRT_TRA.BIN	50000100	00002380	200

Do NOT remove link or power off target while program is running!

Sending of the transfer program NRT-TRA.BIN is thus signaled.

```
R&S FLASHPRO Batchmode V 2.1
```

===== nrt40.cnf =====				
Executing complete programming procedure				
Task	File	Startadr	Length	Progress
-----				
Bootstrap				OK
Transfer	NRT_TRA.BIN	50000100	00002380	OK
Erasing	AM29F040	080000	070000	....

Do NOT remove link or power off target while program is running!

The blocks of the flash EPROM to be programmed are erased to enable writing.

```
R&S FLASHPRO Batchmode V 2.1

===== nrt40.cnf =====
Executing complete programming procedure
Task           File           Startadr      Length        Progress
-----
Bootstrap                                OK
Transfer       NRT_TRA.BIN    50000100     00002380     OK
Erasing        AM29F040       080000       070000       OK
Program        NRT.BIN        080000       02CD50       15630
AM29F040

Do NOT remove link or power off target while program is running!
```

Following the erasure of the flash blocks the new firmware NRT.BIN is transferred and stored in the flash EPROMs of the NRT. A counter signals the number of bytes transferred and programmed.

After transfer of the last byte, the program verifies correct transmission of all data and returns a corresponding message to the FLASHPRO. The firmware has been properly transferred if the following message is displayed:

```
R&S FLASHPRO Batchmode V 2.1

===== nrt40.cnf =====
Executing complete programming procedure
Task           File           Startadr      Length        Progress
-----
Bootstrap                                OK
Transfer       NRT_TRA.BIN    50000100     00002380     OK
Erasing        AM29F040       080000       070000       OK
Program        NRT.BIN        080000       02CD50       OK
AM29F040

                                OK

Do NOT remove link or power off target while program is running!
```

The OK message must be acknowledged with the <Enter> key, FLASHPRO is terminated.

**Note:** To start the updated software the NRT must be switched off and restarted.



**Possible errors:**

Errors may occur,

- if the null modem cable has been improperly connected, not properly fixed or disconnected during the update,
- if the power supply has been interrupted or one of the two instruments switched off,
- if the wrong interface (COM1 or COM2) has been selected.

In most of the above error cases the FLASHPRO will return the following or a similar error message:

```
R&S FLASHPRO Batchmode V 2.1

===== nrt40.cnf =====
Executing complete programming procedure
Task          File          Startadr     Length      Progress
-----
Bootstrap    [.]----- Error ----- OK
Transfer     Host Message: Timeout on com1 at
              transferring transfer program      00
              OK
```

Do NOT remove link or power off target while program is running!

Further possible error sources:

- FLASHPRO was started in a wrong directory.
- The configuration file name entered is faulty or incomplete.

FLASHPRO will return the following or a similar error message.

```
R&S FLASHPRO Batchmode V 2.1

[.]----- Information -----
Controlfile nrt40_1.cnf not
accessible
              OK
```

Do NOT remove link or power off target while program is running!

### 4.3 Functional Test

The NRT can be checked for proper functioning in line with Section 5.2, Test Procedure.

### 4.4 Troubleshooting

Most of the functional faults become apparent through obvious signs or are automatically detected by the NRT itself.

Selftests are carried out automatically on power up of the NRT, replacement of the sensor and cyclically during normal measurement mode. The "SENS WARN" message on the display indicates a fault during the selftests. The precise meaning of the error message can be queried in the menu *UTIL-TEST-SENSOR* (see Section 2.5.9).

Some faults may lead to out-of-tolerance values. In this case the performance tests (service manual) should be carried out prior to an attempt to repair.

**Note:** *All errors indicated on the display can be recalled with the command :TEST:SENsOr? via the IEC/IEEE bus or serial RS-232 interface (see Section 3.5.14).*

#### 4.4.1 Detection of Faulty Module

Faults may occur on switching on, when connecting a sensor or in the measurement mode. The causes of faults are listed below according to their probability of occurrence in descending order. The probably faulty module is stated in the righthand column.

**Fault in switch-on sequence:**

Fault description	Cause	Faulty module
Instrument cannot be switched on or immediately switches off again	<b>Battery operation:</b> Battery discharged or functional fault in charger  <b>AC supply operation:</b> (Option NRT-B3 is not fitted) Malfunction in AC supply	Battery or option NRT-B3  Power supply Mainboard
"SENS WARN" message on display	Malfunction in sensor	Sensor

**Fault upon connecting a NAP sensor to option NRT-B1:**

Fault description	Cause	Faulty module
No response on instrument Displayed message: NO SENSOR RESPONSE	Sensor interface or sensor faulty	Mainboard, Option NRT-B1
"SENS WARN" message on display	Malfunction in option NRT-B1	Option NRT-B1

**Fault upon connecting a NRT sensor**

Fault description	Cause	Faulty module
No response on instrument Displayed message: NO SENSOR RESPONSE	Sensor interface or sensor faulty, Fault in processor	Mainboard, sensor
"SENS WARN" message on display	Malfunction in sensor	Sensor

**Note:** *If the NRT does not react on connecting a sensor, please make sure that the appropriate sensor port is selected. If the NRT does not select this port by itself, remove all other sensors, switch off and restart the instrument.*

**Faults in measurement mode**

Fault description	Cause	Module
LCD display failed	Signal path interrupted or processor control faulty	Display Board or Mainboard
No response to keystroke	Keyboard, keyboard decoder	Display Board
RS-232 interface failed	Driver component faulty	Mainboard
IEC-BUS interface failed	IEC/IEEE bus component faulty Clock generator for IEC/IEEE bus component faults	Mainboard
AUX TTL input/output faulty	Input/output faulty	Mainboard
"SENS WARN" message on display	Malfunction in sensor	Sensor

## 4.5 Installation and Removal of Modules

### 4.5.1 Opening the Instrument



**Caution:** Prior to opening the case, switch off the instrument and disconnect the power plug.  
Remove the battery from NRT model with option NRT-B3.

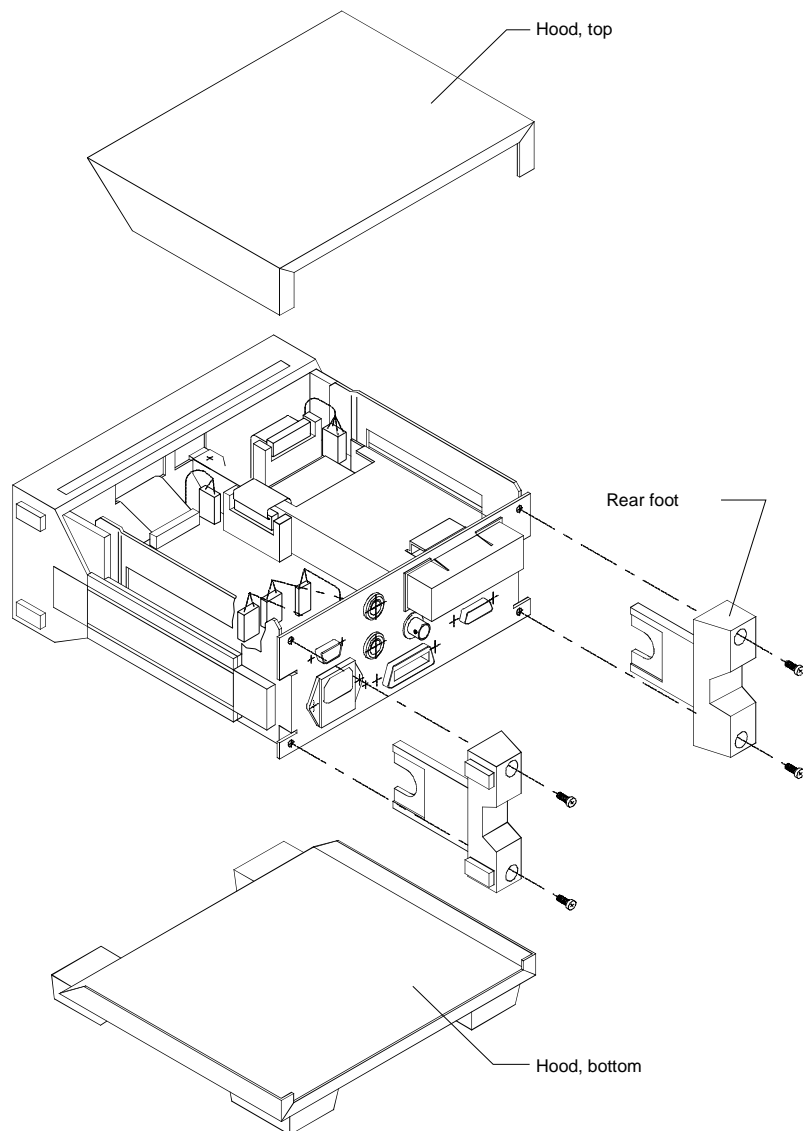

**Fig. 4-3 Removing the top and bottom cover**

**Opening the instrument:**

- Disconnect all cables (power supply, remote control, sensors).
- Undo the four screws of the two rear-panel feet.
- Push the top cover towards the rear panel and detach it.
- Turn the instrument.
- Push the bottom cover towards the rear panel and detach it.

- Closing the instrument:**
- Proceed in reverse order to close the instrument. Press the two covers together when screwing on the rear-panel feet.

**Attention:** Make sure that the braided cord is correctly fitted into the grooves of the case.

#### 4.5.2 Option NRT-B1

- Installation:**
- Open the instrument (Section 4.5.1).
  - Cut out cover plate on rear panel using small side-cutting pliers (see Fig. 4-4).

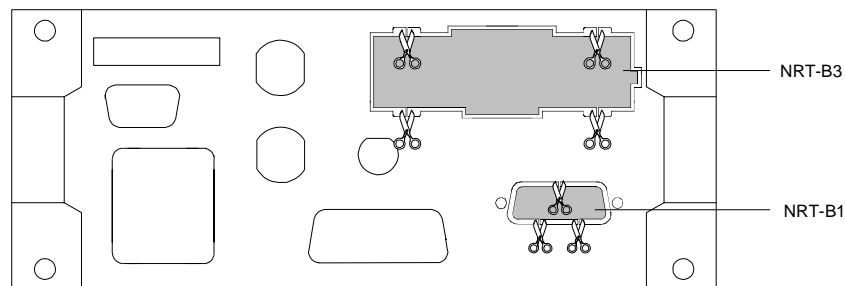

**Fig. 4-4** Removing the cover plates for options NRT-B1 and NRT-B3

- Plug the option, with sub-D connector X1 pointing ahead, into the rear panel from inside the instrument (see Fig. 4-5).
- Fix the option with the two Phillips screws on the wiring side W1.
- Tighten the two nuts of sub-D connector X1.
- Connect cable W1 to the Mainboard (connector X1).
- Close the instrument (Section 4.5.1).

**Removal:** To remove the option, proceed in reverse order.

#### 4.5.3 Option NRT-B2

- Installation:**
- Open the instrument (Section 4.5.1).
  - Remove two round caps from the rear panel (see Fig. 4-5).
  - Insert panel jacks from outside into the rear panel.
  - Slide nut over the cable and tighten it.
  - Plug cable W8 from sensor 2 into connector X81 to X88 and cable W9 from sensor 3 into connector X91 to X98 on the Mainboard. The correct position of the connector is ensured by coding.
  - Set slide switch S1-2 to ON position (Mainboard).
  - Close the instrument (Section 4.5.1).

**Removal:** To remove the option, proceed in reverse order.

#### 4.5.4 Option NRT-B3

- Installation:**
- Open the instrument (Section 4.5.1).
  - Cut out the cover plate on the rear panel using small side-cutting pliers. Make sure that the four bars are not protruding (see Fig. 4-4).
  - Plug the option from inside the instrument into the rear panel (Fig. 4-5).
  - Tighten three Phillips screws.
  - Connect cable W3 to the Mainboard (connector X3). The correct position of the connector is ensured by coding.
  - Close the instrument (Section 4.5.1).
  - Insert battery.

**Removal:** To remove the option, proceed in reverse order.

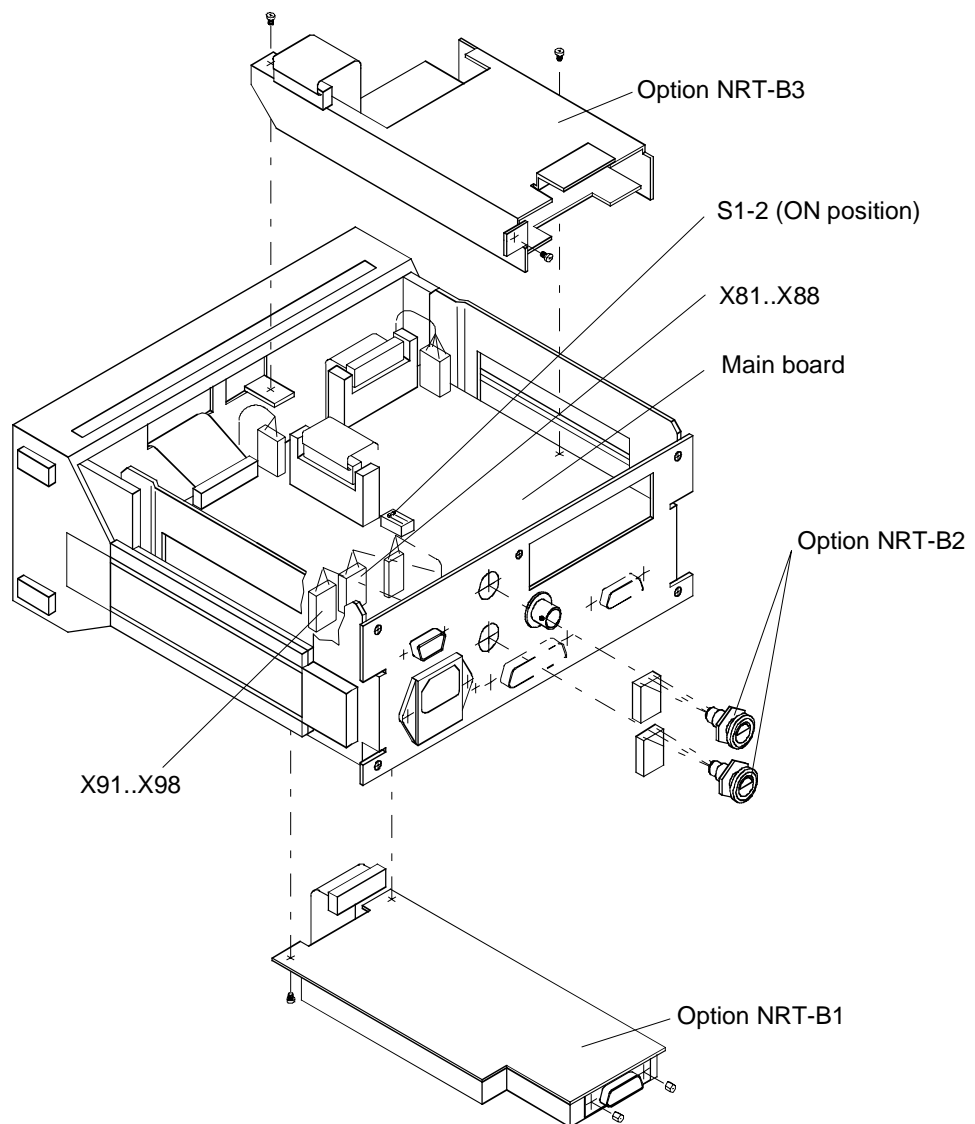

**Fig. 4-5** Installation of options NRT-B1, NRT-B2 and NRT-B3

### 4.5.5 Power Supply

**Removal:**

- Open the instrument (Section 4.5.1).
- Disconnect cable from connector X41 to X44 on Mainboard and disconnect power plug.
- Undo the two Phillips screws on power supply case and remove module (Fig. 4-6).

**Installation:**

To install the power supply, proceed in reverse order.

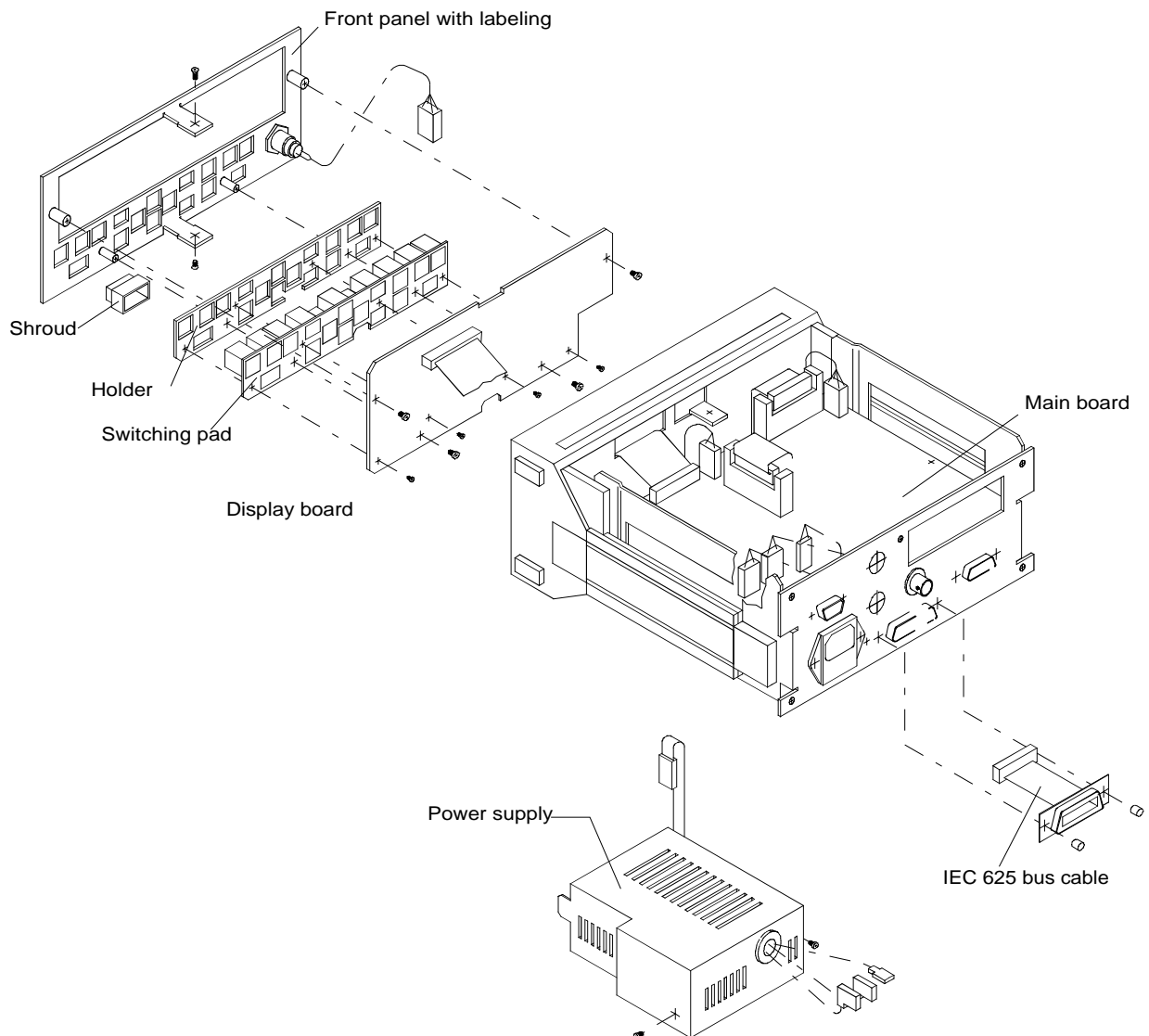

**Fig. 4-6** Installation and removal of power supply, display board and Mainboard

### **4.5.6 Display Board**

- Removal:**
- Open the instrument (Section 4.5.1).
  - Remove plastic cover strip on top of the front frame (lift at the edge with a screwdriver and pull off with caution).
  - Remove the 4 Phillips screws on the front panel and the two Phillips screws in the middle of the top and bottom sections of the front frame (Fig. 4-6).
  - Withdraw display board from the adapter frame towards the front.
  - Disconnect 32-wire cable W5 (connector X5) from the display.
  - Disconnect 6-wire sensor connector from the Mainboard.

**Installation:** To install the display board, proceed in reverse order. The correct position of the connectors X5 and X71 to X78 is ensured by coding.

### **4.5.7 Mainboard**

- Removal:**
- Open the instrument (Section 4.5.1).
  - If fitted, remove options NRT-B1 (4.5.2) and NRT-B3 (4.5.4); see Fig. 4-5.
  - Disconnect all cables from the mainboard (Fig. 4-6).
  - Undo two Phillips screws and remove the two nuts from the connector for the RS-232 interface (X7).
  - Slightly lift the mainboard on the front side, push it towards the front panel and remove it from the instrument.

**Installation:** To install the mainboard, proceed in reverse order. The correct position of the connectors is ensured by coding.



## 5 Checking the Rated Specifications

### 5.1 Measuring Equipment and Accessories

Table 5-1 Measuring equipment and accessories

Ref. No.	Designation	Required specifications	Suitable type	R & S Order Numbers	Use see Section
1	Power meter	Compatible with terminating power sensor (Ref. No. 2)	NRVD NRVS URV35 URV55	0857.8008.02 1020.1809.02 1020.0002.02 (.03) 1029.1701.02	5.1.1 5.2.6.3
2	Terminating power sensor	0 to 30 W, 30 to 1000 MHz Z=50 Ω	NRV-Z54	0858.0800.02	5.1.1 5.2.6.3
3	Signal generator	approx. 120 MHz for NAP-Z3...Z6, Z10, Z11 approx. 30 MHz for NAP-Z7, Z8	SMGL	1020.2005.52	5.1.1 5.2.5 5.2.6.3
4	Power amplifier	Power amplification ≥ 10 dB 30 to 120 MHz, approx. 10 W			5.1.1 5.2.5 5.2.6.3
5	Harmonics filter	Attenuation a) <1 dB / 30 MHz, >40 dB/60 MHz b) <1 dB / 120 MHz >40 dB /200 MHz P ≥ 10 W	ATS-OW	1000.1755.04	5.1.1 5.2.5 5.2.6.3
6	NAP power sensors	Type-specific	NAP-Z3 NAP-Z4 NAP-Z5 NAP-Z6 NAP-Z7 NAP-Z8 NAP-Z9 NAP-Z10 NAP-Z11	392.6610.55 392.6910.55 392.7116.55 392.7316.54 350.8214.02 350.4619.02 392.5513.55 858.0000.02 (.04) 852.6707.02 (.04)	5.1.1 5.2.6.1 5.2.6.2 5.2.6.3
7	NRT-Sensor	Type-specific	NRT-Z44	1081.1309.02	5.2.4 5.2.7
8	IEC/IEEE-bus cable	Connection to IEC 625/IEEE488 standard	PCK	0292.2013.10	5.2.3.1
9	Modem bypass cable	9-wire RS232 cable, RX-TX connections crossed		1050.0346.02	5.2.3.2
10	Process controller	Industry-standard PC/XT/AT with IEC625/IEEE488 and RS232 interface	PSA 5 PSA 15 PSA 17	1006.3008.03 1012.1003.02 1026.1000.03	5.2.3 5.2.4 5.2.6.3
11	DC voltmeter	0 to > 5V			5.2.5

### 5.1.1 Test Setup for Checking the Option NRT-B1

Test setup:

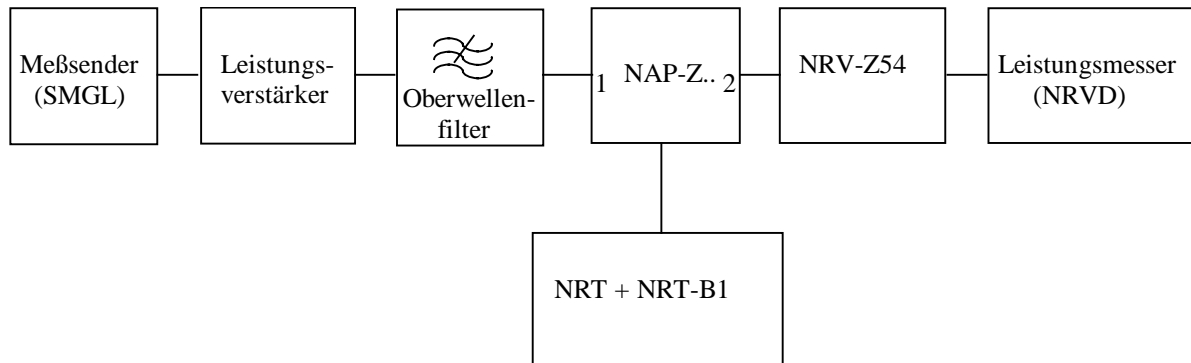

## 5.2 Test Procedure

After power up the NRT checks all sensor interfaces for sensors being connected and all options. If a fault is detected, an error message or warning is displayed. Faults are located according to Section 4.4, Trouble Shooting. Further tests can be triggered in the *UTILity - TEST* menu (Section 2.5.11, Test (Built-in Tests)).

### 5.2.1 Switch-On Sequence

- Preparation: ➤ Connect the NRT without sensors to the AC supply.
- Test: The NRT should be automatically switched on without actuation of the *ON/STBY* key.
- Switch off and restart the NRT using the *ON/STBY* key.

### 5.2.2 Display and Keypad

#### 5.2.2.1 Display Test

- Preparation: ➤ Select the function parameter *LCD* in the *UTIL - TEST* menu.
- Test: All segments in the display should be shown until the *SEL(LOCAL)* key is pressed again.

### 5.2.2.2 Keypad Test

- Preparation: ➤ Select the function parameter *KEY* in the *UTIL - TEST* menu.
- Test: ➤ Press all keys, except for the *ON/STBY* key, successively.  
The designation of each key pressed should be shown on the display. The test is completed if one and the same key is pressed twice.

### 5.2.2.3 Acoustic Signal Device

- Preparation: ➤ Switch on signal device in the *UTIL - BEEPER* menu (ON).
- Test: Pressing any key should be acoustically confirmed.

### 5.2.2.4 Memory Test

- Preparation: ➤ Select the function parameter *MEM* in the *UTIL - TEST* menu.  
After each successfully carried out test step, <tested memory> 'OK' should be displayed.

## 5.2.3 Remote Control

The interfaces are checked by means of a communication test between the NRT and the PC connected. The DUT should respond to the message sent by the PC by returning a string containing the identification data of the NRT.

Measuring equipment: Process controller (Table 5-1, Ref. No. 10)

### 5.2.3.1 IEC/IEEE BUS (IEC625 / IEEE488 Interface)

- Preparation: ➤ Connect the IEC625/IEEE488 interfaces of the NRT and the controller via the IEC/IEEE-bus cable.  
➤ Activate the IEC/IEEE bus interface on the NRT in the *UTIL - REMOTE* menu and set the IEC/IEEE address to 12.
- Test: ➤ Send \*IDN? from the controller to address 12 and read out the response string of the NRT.  
The response string should contain the following information:  
'ROHDE & SCHWARZ,NRT<Var>,<Ser\_No>,<Firmware\_Vers.\_No>'

### 5.2.3.2 RS232 Interface

- Preparation:
- Connect the RS232 interfaces of the NRT and the controller via modem bypass cable.
  - Select on the NRT in the *UTIL - REMOTE* menu the serial RS232-interface, set the transfer rate to 9600 baud and select XON/XOFF handshake mode.
  - Set the RS232 interface of the controller to 8 data bits, 1 start bit, 1 stop bit, no parity bit, XON/XOFF handshake, and 9600 baud.

- Test:
- Send '\*IDN?<CR><NL>' from the controller to the NRT and read out the response string of the NRT.

The response string should contain the following information:

'ROHDE & SCHWARZ,NRT<Var>,<Ser\_No>,<Firmware\_Vers.\_No>'

### 5.2.4 Sensor Interface

The interface is checked by means of a communication test between the NRT and the sensor connected.

- Preparation:
- Switch on the NRT without sensor.  
The warning 'NO SENSOR RESPONSE' should be displayed.

- Test:
- Connect Sensor NRT-Z44 to sensor port 1 (front panel).  
The messages 'FOUND SENSOR<s> 1.' and 'INITIALIZING...' must be displayed one after another. The applied power should then be displayed.  
In case of fault, the error message 'SENS WARN' will be displayed.

### 5.2.5 AUX Interface

The test is made with constant forward power by changing the conditions for the output of TTL high level (within/out of bargraph indication range).

- Preparation:
- Connect a DC voltmeter to the AUX connector of the NRT in a test setup as shown in 5.1.1 (sensor according to Table 5-1, Ref. No. 7 or Ref. No. 6)
  - Set the measurement mode with the AVG/ENV function key to AVG, the measurement unit with the dBm/Δ/W key to W.
  - Set the range of the forward power indication bargraph to 0 to 3 W according to Section 2.2.3.
  - Select in the *UTIL - AUX/IO - OUT - PWR* submenu the parameter *INBND*.
  - Adjust the signal generator so that a forward power of 1 W is indicated on the NRT.

- Test:
- TTL high level (>3V) should be output at the AUX output.
  - Select in the *UTIL - AUX/IO - OUT - PWR* submenu the parameter *OUTBND*.  
TTL low level (<0.8 V) should be output at the AUX output.

## 5.2.6 Option NRT-B1

The option NRT-B1 is checked in conjunction with the NAP sensors (see Table 5-1, Ref. No. 6). The power measurement range and the signal weighting are sensor-specific.

Before the measurements are started the sensor used should be warmed-up for at least 5 minutes.

The tolerances specified in the test report (Table 5-2) already contain all measurement uncertainties of the test setup.

### 5.2.6.1 Sensor Identification

- Test:
- Disconnect all sensors.
  - Connect the NAP sensor to option NRT-B1 (rear panel).  
The messages 'FOUND SENSOR<s> 1.' and 'INITIALIZING...' must be displayed one after another. Measured values should then be displayed.  
In case of fault, the error message 'SENS WARN' will be displayed.

### 5.2.6.2 Zeroing

- Preparation:
- Arrange test setup as shown in 5.1.1.
  - Set the measurement mode with the *AVG/ENV* function key to *AVG*, the measurement unit with the *dBm/Δ/W* key to *W*.
  - Configure the display via the submenus *CONFIG - RESOL => HIGH*, *CONFIG - POWER => FWD*, *CORR - DIRECTION => AUTO* and *CORR - FREQ => DEF*.
- Test:
- Carry out zeroing via the *CORR - ZERO - EXEC* menu parameter.  
After correct zeroing, measured values must be displayed.  
The message 'NO ZEROING <POWER IS ON>' signals faulty zeroing.
  - If necessary switch off the test power and repeat zeroing.
  - Check zeroing with another sensor. With repeatedly faulty zeroing, there is a fault in option NRT-B1.

### 5.2.6.3 Power Measurement

Preparation: ➤ Adjust signal generator (usually approx. 100 MHz; 30 MHz for NAP-Z7,-Z8; CW) so that the measured power on the reference power meter is approx. 10 W (approx. 1 W for NAP-Z9).

Test:

Direction 1 → 2 ➤ Determine the deviation in percent of the indicated forward power of the DUT from the measured value of the reference power meter and enter the result into the test report. Switch off the test power.

Direction 2 → 1 ➤ Reverse the NAP sensor in the test setup shown under 5.1.1 (sensor port 2 to signal generator).  
 ➤ Repeat the measurement as described for the other direction.  
 ➤ Determine the deviation in percent of the indicated forward power of the DUT from the measured value of the reference power meter and enter the result into the test report. Switch off the test power.

### 5.2.7 Option NRT-B2

- Check option NRT-B2 (two additional sensor interfaces, Sensor 2 and Sensor 3, on the NRT rear panel) accordingly in line with Section 5.2.4.

### 5.2.8 Option NRT-B3

The option is checked with a charged battery inserted.

#### 5.2.8.1 Switchover AC Supply/Battery Operation

Preparation: ➤ Connect the NRT to the AC supply.  
 ➤ Switch on the NRT with the *ON/STBY* key and wait for completion of switch-on process.  
 ➤ Select in the *UTIL - BATTERY CHARGE* menu the parameter *ON*.

Test: The battery charging symbol (danger arrow + battery) should light on the display.  
 ➤ Disconnect the power cord (no AC supply).  
 The power disconnect should not be indicated on the NRT. The instrument should remain switched on.  
 The charging symbol on the display (danger arrow) should disappear, the battery symbol for indicating battery operation should be retained.  
 ➤ Connect the power cord (restore AC supply).  
 The battery charging symbol should light on the display.  
 ➤ Select the parameter *OFF* in the *UTIL - BATTERY CHARGE* menu.  
 The battery charging symbol should disappear.

### 5.2.8.2 Battery Identification

- Preparation:
- Remove battery.
  - Connect the power cord and wait for completion of the switch-on process.
  - Plug in the battery.
- Test: The charging symbol appears on the display.

### 5.2.8.3 Automatic Switch-Off of Charging

- Preparation:
- Connect NRT to AC supply, insert battery into option NRT-B3.
  - Switch on the NRT with the *ON/STBY* key and wait for completion of switch-on process.
  - Select in the *UTIL - BATTERY CHARGE* menu the parameter *ON*.
- Test: The battery charging symbol should disappear after max. 2.5 hours (end of charging). The charging time can be considerably reduced with the battery only partly discharged.
- If charging is completed later, repeat the check with another battery.

### 5.3 Test Report

<b>ROHDE &amp; SCHWARZ</b>	<b>Power Reflection Meter NRT</b>	<b>1080.9506.02</b>
Serial No.:		
Responsible:		
Date:		
Signature:		

**Table 5-2 Test report**

Ref. No.	Function	Measured acc. to Section	Min.	Actual	Max.	Unit
1	Switch-on process	5.2.1	-----		-----	-----
2	Display test	5.2.2.1	-----		-----	-----
3	Keypad test	5.2.2.2	-----		-----	-----
4	Acoustic signal device	5.2.2.3	-----		-----	-----
5	Memory test	5.2.2.4	-----		-----	-----
6	IEC/IEEE BUS (IEC625 / IEEE488-interface)	5.2.3.1	-----		-----	-----
7	RS232 interface	5.2.3.2	-----		-----	-----
8	Sensor interface	5.2.4	-----		-----	-----
9	AUX interface	5.2.5	-----		-----	-----
10	Option NRT-B1 Sensor identification NAP- Z__	5.2.6.1	-----		-----	-----
11	Option NRT-B1 Zeroing NAP-Z__	5.2.6.2	-----		-----	-----
12	Option NRT-B1 Power measurement NAP-Z__ Direction 1 → 2	5.2.6.3	-8		8	% *)
13	Option NRT-B1 Power measurement NAP-Z__ Direction 2 → 1	5.2.6.3	-8		8	% *)
14	Option NRT-B2	5.2.7	-----		-----	-----
15	Option NRT-B3 Switchover AC supply/battery operation	5.2.8.1	-----		-----	-----
16	Option NRT-B3 Battery identification	5.2.8.2	-----		-----	-----
17	Option NRT-B3 Automatic switch-off of charging	5.2.8.3	2		132	minutes

\*) Uncertainties of test setup included in tolerances.



## Annex A Interfaces

### Annex A.1 IEC/IEEE Bus Interface

The standard instrument is equipped with an IEC/IEEE-bus connection. The IEEE 488 interface connector is located on the rear panel of the instrument. A controller for remote control can be connected via the IEEE 488 interface using a shielded cable.

#### Annex A.1.1 Characteristics of the Interface

- 8-bit parallel data transfer,
- bidirectional data transfer,
- three line handshake,
- high data transfer rate of max. 350 kByte/s,
- up to 15 devices can be connected,
- maximal length of the connecting cables 15 m (single connection 2m),
- wired OR if several instruments are connected in parallel.

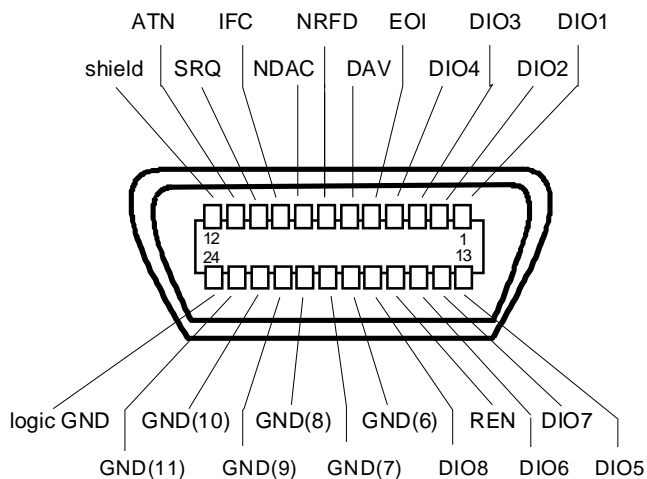

Fig. A-1 Pin Assignment of the IEC-bus interface

#### Annex A.1.2 Bus Lines

##### 1. Data bus with 8 lines DIO 1 to DIO 8.

The transmission is bit-parallel and byte-serial in the ASCII/ISO code. DIO1 is the least significant bit, DIO8 the most significant bit.

## 2. Control bus with 5 lines

### IFC (Interface Clear),

active LOW resets the interfaces of the instruments connected to the default setting.

### ATN (Attention),

active LOW signals the transmission of interface messages  
inactive HIGH signals the transmission of device messages.

### SRQ (Service Request),

active LOW enables the connected device to send a service request to the controller.

### REN (Remote Enable),

active LOW permits switchover to remote control.

### EOI (End or Identify),

has two functions in connection with ATN:

ATN=HIGH active LOW marks the end of data transmission.

ATN=LOW active LOW triggers a parallel poll.

## 3. Handshake bus with three lines

### DAV (Data Valid),

active LOW signals a valid data byte on the data bus.

### NRFD (Not Ready For Data),

active LOW signals that one of the connected devices is not ready for data transfer.

### NDAC (Not Data Accepted),

active LOW signals that the instrument connected is accepting the data on the data bus.

## Annex A.1.3 Interface Functions

Instruments which can be remote controlled via IEC bus can be equipped with different interface functions. Table A-1 lists the interface functions valid for the NRT.

**Table A-1 Interface functions**

Control character	Interface function
SH1	Handshake source function (source handshake)
AH1	Handshake drain function (acceptor handshake)
L4	Listener function
T6	Talker function, ability to respond to serial poll
SR1	Service request function
PP1	Parallel poll function
RL1	Remote/Local switchover function
DC1	Reset function (Device Clear)
DT1	Trigger function (Device Trigger)

## Annex A.1.4 Interface Messages

Interface messages are transmitted to the instrument on the data lines, with the attention line being active (LOW). They serve to communicate between controller and instrument.

### Universal Commands

Universal commands are encoded in the range 10 through 1F hex. They are effective for all instruments connected to the bus without previous addressing.

**Table A-2 Universal Commands**

Command	QuickBASIC command	Effect on the instrument
DCL (Device Clear)	IBCMD (controller%, CHR\$(20))	Aborts processing of the commands just received and sets the command processing software to a defined initial state. Does not change the instrument setting.
IFC (Interface Clear)	IBSIC (controller%)	Resets the interfaces to the default setting.
LLO (Local Lockout)	IBCMD (controller%, CHR\$(17))	The LOC/IEC ADDR key is disabled.
SPE (Serial Poll Enable)	IBCMD (controller%, CHR\$(24))	Ready for serial poll.
SPD (Serial Poll Disable)	IBCMD (controller%, CHR\$(25))	End of serial poll.
PPU (Parallel Poll Unconfigure)	IBCMD (controller%, CHR\$(21))	End of the parallel-poll state.

### Addressed Commands

Addressed commands are encoded in the range 00 through 0F hex. They are only effective for instruments addressed as listeners.

**Table A-3 Addressed Commands**

Command	QuickBASIC command	Effect on the instrument
SDC (Selected Device Clear)	IBCLR (device%)	Aborts processing of the commands just received and sets the command processing software to a defined initial state. Does not change the instrument setting.
GET (Group Execute Trigger)	IBTRG (device%)	Triggers a previously active device function. The effect of the command is the same as with that of a pulse at the external trigger signal input.
GTL (Go to Local)	IBLOC (device%)	Transition to the "Local" state (manual control).
PPC (Parallel Poll Configure)	IBPPC (device%, data%)	Configure instrument for parallel poll. The QuickBASIC command additionally executes PPE / PPD.

## Annex A.2 RS-232-C Interface

The standard instrument is equipped with an RS-232-C interface. The 9-pin connector is located on the rear panel. A controller can be connected via this interface for remote control.

### Annex A.2.1 Interface characteristics

- Serial data transmission in asynchronous mode,
- Bidirectional data transmission via two separate lines,
- Transmission rate selectable from 1200 to 9600 baud,
- Logic 0 signal from +3 V to +15 V,
- Logic 1 signal from -15 V to -3 V,
- An external instrument (controller) can be connected,
- Hardware handshake RTS/CTS and software handshake XON/XOFF can be selected.

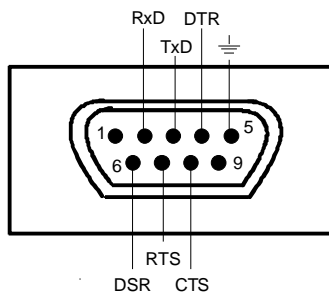

Fig. A-2 Pin assignment of the RS-232-C interface

### Annex A.2.2 Signal lines

**RxD** (Receive Data),

Input; data line for transmitting from remote station to local terminal.

**TxD** (Transmit Data),

Output; data line for transmitting from local terminal to remote station.

**DTR** (Data Terminal Ready),

Output (log. '0' = active); with DTR, the instrument indicates that it is ready to receive data.

**GND** (Ground),

Interface ground, connected to instrument ground.

**DSR** (Data set ready),

Input (log. '0' = active); DSR indicates to the instrument that the remote station is ready to receive data.

**RTS** (Request to send),

Output (log. '0' = active); with RTS, the instrument indicates that it is ready to receive data. The RTS line controls whether the instrument is ready to receive data or not.

**CTS** (Clear to send),

Input (log. '0' = active); CTS tells the instrument that the remote station is ready to receive data.

### Annex A.2.3 Transmission parameters

In order to ensure error-free and correct data transmission, the parameters of the instrument and the controller must be set identically. The parameters are defined in the *UTILITIES-SYSTEM-RS232* menu.

**Transmission rate (baud rate)** Four different baud rates can be set in the instrument: 1200, 2400, 4800, 9600.

**Data bits** Data transmission is in 8-bit ASCII code. The first bit transmitted is the LSB (Least Significant Bit).

**Start bit** Each data byte begins with a start bit. The falling edge of the start bit indicates the beginning of the data byte.

**Parity bit** No parity bit is used.

**Stop bit** The transmission of a data byte is terminated by a stop bit.

**Example:**

Transmission of character A (41 hex) in the 8-bit ASCII code.

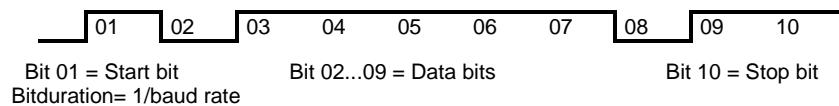

### Annex A.2.4 Interface functions

For interface control, some control characters from the ASCII code range of 0 to 20 hex are predefined and can be transmitted via the interface (see Table A-4).

**Table A-4 Control strings or control characters of the RS-232-C interface**

Control Character	Function
Break (at least 1 character only log 0)	Reset instrument
0Dhex, 0Ahex	Terminator <CR>, <LF> Switchover between local/remote

### Annex A.2.5 Handshake

#### Software handshake

The standard NRT supports the XON/XOFF software handshake.

#### Hardware handshake

In case of a hardware handshake, the instrument signals that it is ready for reception via line DTR and RTS. A logic '0' means "ready" and a '1' means "not ready".

The CTS or DSR lines (see signal lines) tell the instrument whether the controller is ready for reception or not. The transmitter of the instrument is switched on by a '0' and switched off by a '1'. The RTS line remains active as long as the serial interface is active. The DTR line controls whether the instrument is ready for reception or not.

#### Connection between instrument and controller (null modem cable, R&S 1050.0346.00)

The connection of the instrument to a controller is made with a so-called null modem cable. Here, the data, control and signalling lines must be crossed. The following wiring diagram applies to a controller with a 9-pin or 25-pin configuration.

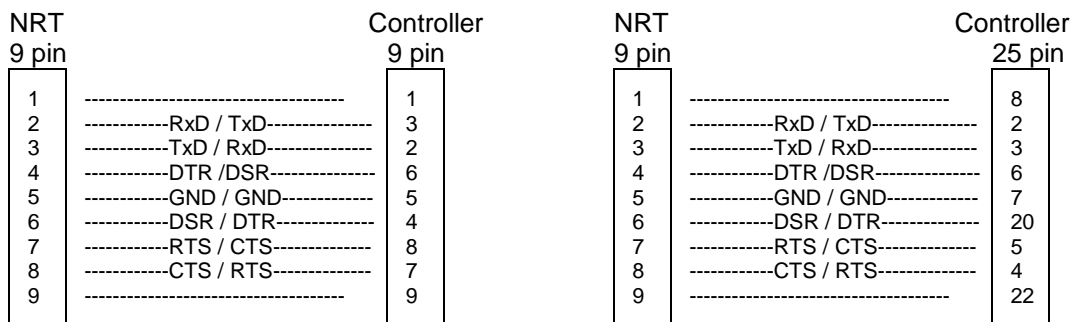

Fig. A-3 Null modem connection scheme

## Annex B List of Error Messages

The following list contains all error messages for errors occurring in the instrument. The meaning of negative error codes is defined in SCPI, positive error codes mark errors specific of the instrument.

The table contains the error code in the left-hand column. In the right-hand column, the error text being entered into the error/event queue or being displayed is printed in bold face. Below the error text, there is an explanation as to the respective error.

### Annex B.1 SCPI-Specific Error Messages

No Error

Error code	Error text in the case of queue poll Error explanation
0	<b>No error</b> This message is output if the error queue does not contain any entries.

Command Error - Faulty command; sets bit 5 in the ESR register

Error code	Error text in the case of queue poll Error explanation
-100	<b>Command Error</b> The command is faulty or invalid.
-101	<b>Invalid Character</b> The command contains an invalid character. Example: A header contains an ampersand, ":SOURCE&".
-102	<b>Syntax error</b> The command is invalid. Example: The command contains block data the instrument does not accept.
-103	<b>Invalid separator</b> The command contains an illegal character instead of a separator. Example: A semicolon is missing after the command.
-104	<b>Data type error</b> The command contains an invalid data element. Example: ON is encountered instead of a numeric value for frequency setting.
-105	<b>GET not allowed</b> A Group Execute Trigger (GET) is within a command line.
-108	<b>Parameter not allowed</b> The command contains too many parameters. Example: Command :SENSe<n>:POWer:REFeRence permits only one parameter for the power.

Command Errors (contd.):

Error code	Error text in the case of queue poll Error explanation
-109	<p><b>Missing parameter</b> The command contains too few parameters. Example: Command :SENSE&lt;n&gt;:POWER:REFERENCE requires input of a power.</p>
-110	<p><b>Command header error</b> The header of the command is faulty.</p>
-111	<p><b>Header separator error</b> The header contains an illegal separator. Example: The header is not followed by a "White space", "ESE255"</p>
-112	<p><b>Program mnemonic too long</b> The header contains more than 12 characters.</p>
-113	<p><b>Undefined header</b> The header is not defined for the instrument. Example: *XYZ is undefined for every instrument.</p>
-114	<p><b>Header suffix out of range</b> The header contains an illegal numeric suffix. Example: :SENSE8 does not exist in the instrument.</p>
-120	<p><b>Numeric data error</b> The command contains a faulty numeric parameter.</p>
-121	<p><b>Invalid character in number</b> A number contains an invalid character. Example: An "A" in a decimal number or a "9" in an octal number.</p>
-123	<p><b>Exponent too large</b> The absolute value of the exponent is larger than 32000.</p>
-124	<p><b>Too many digits</b> The number contains too many digits.</p>
-128	<p><b>Numeric data not allowed</b> The command contains a number which is not allowed at this position. Example: Command :SENSE&lt;n&gt;:FUNCTION:ON requires specification of a text parameter.</p>
-130	<p><b>Suffix error</b> The command contains a faulty suffix.</p>
-131	<p><b>Invalid suffix</b> The suffix is invalid for this instrument. Example: nHz is not defined.</p>
-134	<p><b>Suffix too long</b> The suffix contains more than 12 characters.</p>
-138	<p><b>Suffix not allowed</b> A suffix is not allowed for this command or at this position of the command. Example: Command *RCL does not permit specifying a suffix.</p>
-140	<p><b>Character data error</b> The command contains a faulty text parameter.</p>
-141	<p><b>Invalid character data</b> The text parameter either contains an invalid character or it is invalid for this command. Example: Parameter input with write error :SENSE&lt;n&gt;:BURSt:MODE USSER</p>



## Command Errors (contd.):

Error code	Error text in the case of queue poll Error explanation
-144	<b>Character data too long</b> The text parameter contains more than 12 characters.
-148	<b>Character data not allowed</b> The text parameter is not allowed for this command or at this position of the command. Example: Command *RCL requires a number to be specified.
-150	<b>String data error</b> The command contains a faulty string.
-151	<b>Invalid string data</b> The command contains a faulty string. Example: An END message was received before the terminal quote character.
-158	<b>String data not allowed</b> The command contains a valid character string at a position which is not allowed. Example: A text parameter is set in quotation marks, :SENSe<n>:BURSt:MODE "USER "
-160	<b>Block data error</b> The command contains faulty block data.
-161	<b>Invalid block data</b> The command contains faulty block data. Example: An END message is received before the expected number of data was received.
-168	<b>Block data not allowed</b> The command contains valid block data at an illegal position.
-170	<b>Expression error</b> The command contains an invalid mathematical expression.
-171	<b>Invalid expression</b> The command contains an invalid mathematical expression. Example: The expression contains mismatching parentheses.
-178	<b>Expression data not allowed</b> The command contains a mathematical expression at an illegal position.
-180	<b>Macro error</b> A faulty macro has been defined, or an error has occurred during execution of a macro.
-181	<b>Invalid outside macro definition</b> A macro parameter placeholder was encountered outside a macro definition.
-183	<b>Invalid inside macro definition</b> A macro is syntactically wrong.
-184	<b>Macro parameter error</b> A command inside the macro definition has the wrong number or type of parameters.

Execution Error - Error in executing the command; sets bit 4 in the ESR register

Error code	Error text in the case of queue poll Error explanation
-200	<b>Execution error</b> Error on execution of the command.
-201	<b>Invalid while in local</b> The command is not executable while the device is in local due to a hard local control.
-202	<b>Settings lost due to rtl</b> A setting associated with hard local control was lost when the device changed to LOCS from REMS or to LWLS from RWLS.
-210	<b>Trigger error</b> Error on triggering the device.
-211	<b>Trigger ignored</b> The trigger (GET, *TRG or trigger signal) was ignored due to device timing considerations. Example: The device was not ready to respond.
-212	<b>Arm ignored</b> An arming signal was ignored by the instrument.
-213	<b>Init ignored</b> Measurement initialization was ignored as another measurement was already in progress.
-214	<b>Trigger deadlock</b> The trigger signal can not be used. (The trigger source for the initiation of measurement is set to GET and the subsequent query is received. The measurement cannot be started until a GET is received, but the GET would cause an interrupted-error.)
-215	<b>Arm deadlock</b> The arming signal can not be used.
-220	<b>Parameter error</b> The command contains a faulty or invalid parameter.
-221	<b>Settings conflict</b> There is a settings conflict between two parameters. Example: FM1 and PM1 cannot be switched on at the same time.
-222	<b>Data out of range</b> The parameter value is out of the range permitted by the instrument. Example: Command *RCL only permits entries in the range of 0 to 4
-223	<b>Too much data</b> The command is valid but contains too much data. Example: The instrument does not have sufficient storage space.
-224	<b>Illegal parameter value</b> The parameter value is invalid. Example: An invalid text parameter is specified, :INPut:PORT:POStion MIDDLE

## Execution Errors (contd.)

Error code	Error text in the case of queue poll Error explanation
-230	<b>Data corrupt or stale</b> The data are incomplete or invalid. Example: The instrument has aborted a measurement.
-231	<b>Data questionable</b> The measurement accuracy is suspect.
-240	<b>Hardware error</b> The command cannot be executed due to problems with the instrument hardware.
-241	<b>Hardware missing</b> The command cannot be executed due to missing hardware. Example: An option is not fitted.
-250	<b>Mass storage error</b> A mass storage error occurred.
-251	<b>Missing mass storage</b> The command can not be executed due to missing mass storage. Example: An option is not installed.
-252	<b>Missing media</b> The command can not be executed due to missing storage media. Example: No floppy in the floppy disk drive.
-253	<b>Corrupt media</b> The media is corrupt. Example: The floppy is bad or has a wrong format.
-254	<b>Media full</b> The media is full. Beispiel: There is no room on the floppy.
-255	<b>Directory full</b> The media directory is full.
-256	<b>File name not found</b> The file name can not be found on the media..
-257	<b>File name error</b> The file name is faulty. Beispiel: An attempt is made to copy to a duplicate file name.
-258	<b>Media protected</b> The media is protected. Beispiel: The write-protect tab on the floppy is present.
-260	<b>Expression error</b> The command contains a faulty mathematical expression.
-261	<b>Math error in expression</b> The expression contains a mathematical error. Example: Divide-by-zero.

## Execution Errors (contd.)

Error code	Error text in the case of queue poll Error explanation
-270	<b>Macro error</b> Error on executing a macro.
-271	<b>Macro syntax error</b> The macro definition contains a syntax error.
-272	<b>Macro execution error</b> The macro definition contains an error.
-273	<b>illegal macro label</b> The macro label defined in the DMC*-command is illegal. Example: The label is too long. The label is identical with the common command header or contains an invalid header syntax.
-274	<b>Macro parameter error</b> The definition improperly uses a macro parameter placeholder.
-275	<b>Macro definition too long</b> The macro definition is too long.
-276	<b>Macro recursion error</b> The command sequence defined by the macro is trapped in a program loop. Example: The event that would allow the loop to be exited does not occur.
-277	<b>Macro redefinition not allowed</b> The macro label defined in the *DMC command is already defined elsewhere.
-278	<b>Macro header not found</b> The header of the macro label in the *GMC?-query is not yet defined
-280	<b>Program error</b> Error on execution of a downloaded program.
-281	<b>Cannot create program</b> An attempt to create the program failed.
-282	<b>illegal program name</b> The name of the program is illegal. Example: Attempt to delete a nonexistent program.
-283	<b>illegal variable name</b> The entered variable does not exist in the program.
-284	<b>Program currently running</b> The desired operation is not possible while the program is running.
-285	<b>Program syntax error</b> The down-loaded program contains a syntax error.
-286	<b>Program runtime error</b>

Device Specific Error - sets bit 3 in the ESR register.

Error code	Error text in the case of queue poll Error explanation
-300	<b>Device-specific error</b> NRT-specific error not defined in more detail.
-310	<b>System error</b> This error message suggests a device-dependent error. Please inform the R&S Service.
-311	<b>Memory error</b> Error in the device's memory.
-312	<b>PUD memory lost</b> Loss of the protected user data stored using the *PUD command.
-313	<b>Calibration memory lost</b> Loss of non-volatile calibration data used by the *CAL? command.
-314	<b>Save/recall memory lost</b> Loss of the non-volatile data stored using *SAV? command.
-315	<b>Configuration memory lost</b> Loss of the non-volatile configuration data stored by the instrument.
-330	<b>Self-test failed</b> The selftest could not be executed.
-350	<b>Queue overflow</b> This error code is entered into the queue instead of the actual error code if the queue is full. It indicates that an error has occurred but not been accepted. The queue can accept 5 entries.

Query Error - Error in data request; sets bit 2 in the ESR register.

Error code	Error text in the case of queue poll Error explanation
-400	<b>Query error</b> General error occurring when data are requested by a query.
-410	<b>Query INTERRUPTED</b> The query has been interrupted. Example: After a query, the instrument receives new data before the response has been sent completely.
-420	<b>Query UNTERMINATED</b> The query is incomplete. Example: The instrument is addressed as a talker and receives incomplete data.
-430	<b>Query DEADLOCKED</b> The query cannot be processed. Example: The input and output buffers are full, the instrument cannot continue operation.
-440	<b>Query UNTERMINATED after indefinite response</b> A query is in the same command line after a query which requests an indefinite response.

**Annex B.2 NRT-Specific Error Messages**

Device-dependent Error - device-specific error; sets bit 3 in the ESR register.

<b>Error code</b>	<b>Error text in the case of queue poll</b> Error explanation
300	<b>SWR overrange</b> The SWR limit control signals that the SWR is beyond the limit value allowed.
301	<b>Out of Range</b> The domain control signals the signal is outside the allowed range.

## Annex C List of Commands

### Annex C.1 List of Commands with SCPI Conformity Information

The NRT supports SCPI version 1995.0.

For remote control, commands which were specified or recognized in this SCPI version have been used to a large extent. Commands which are not part of the SCPI specification are marked "not SCPI" in the SCPI info field.

Command	Parameters	SCPI Info	Page
:CALCulate<n>:LIMit	–		3.21
:CALCulate<n>:LIMit:TYPE	MINimum   MAXimum   DIFFerence		3.21
:CALCulate<n>:LIMit[:STATe]	ON   OFF		3.21
:CALibration<n>:ZERO	–		3.22
:CALibration0	–		3.22
:CALibration0:FREQuency<m>:DATA	<Frequency Array>	not SCPI	3.23
:CALibration0:LOAD<m>:DATA	<Calibration Factor Array CF12>	not SCPI	3.23
:CALibration0:SOURce<m>:DATA	<Calibration Factor Array CF21>	not SCPI	3.23
:CALibration0:STATe<m>	ON   OFF		3.23
:CONTRol:POWer:BATTery:CHArge	ON   OFF	not SCPI	3.24
:CONTRol:POWer:BATTery:ACHArge	ON   OFF	not SCPI	3.24
:CONTRol:POWer:DELay	300   1200   7200 s   MINimum   MAXimum   DEFault	not SCPI	3.24
:CONTRol:POWer[:STATe]	ON   OFF	not SCPI	3.24
:DIAGnostic:INFO:OTIMe?	–		3.25
:INPut<n>:PORT:OFFSet	0 dB ... 100 dB MINimum   MAXimum   DEFault	not SCPI	3.26
:INPut<n>:PORT:POSition	SOURCE   LOAD	not SCPI	3.26
:INPut<n>:PORT:SOURce	1   2   DEFault	not SCPI	3.26
:INPut<n>:PORT:SOURce:AUTO	ON   OFF	not SCPI	3.26
:SENSe<n>:BANDwidth   BWIDth:VIDeo:FNUMber	<f>		3.30
:SENSe<n>:BURSt:MODE	AUTO   USER	not SCPI	3.30
:SENSe<n>:BURSt:PERiod	0..1s   MINimum   MAXimum	not SCPI	3.30
:SENSe<n>:BURSt:WIDTh	0..1s   MINimum   MAXimum	not SCPI	3.30
:SENSe<n>:DATA?	[<Measurement Function>]		3.33
:SENSe<n>:DM:STANdard	IS95   WCDMa   DVBT   DAB	not SCPI	3.31
:SENSe<n>:DM:STATe	ON   OFF	not SCPI	3.31
:SENSe<n>:DM:WCDMA:CRATe	0..8.2E6   MINimum   MAXimum   DEFault	not SCPI	3.31

Command	Parameters	SCPI Info	Page
:SENSe<n>:FREQUency[:CW]:FIXED]	0..200GHz   MINimum   MAXimum   DEFault		3.31
:SENSe<n>:FUNction:CONCurent	ON   OFF		3.31
:SENSe<n>:FUNction:OFF	<Measurement Function>		3.32
:SENSe<n>:FUNction:OFF:ALL<m>	–		3.32
:SENSe<n>:FUNction:STATe?	<Measurement Function>		3.33
:SENSe<n>:FUNction[:ON]	<Measurement Function>		3.32
:SENSe<n>:INformation?	–	not SCPI	3.33
:SENSe<n>:POWer:APERture	0.005s ... 0.111s   MINimum   MAXimum   DEFault	not SCPI	3.33
:SENSe<n>:POWer:CCDFunction:REFerence	0..100E6 W   -200..+200dBm   MINimum   MAXimum	not SCPI	3.34
:SENSe<n>:POWer:REFerence	0..100E6 W   -200..+200dBm   MINimum   MAXimum	not SCPI	3.34
:SENSe<n>:POWer:REFlection:RANGe:AUTO	ON   OFF	not SCPI	3.35
:SENSe<n>:POWer:REFlection:RANGe:LIMit:DETECT	INBound   OUTBound   HIGH	not SCPI	3.36
:SENSe<n>:POWer:REFlection:RANGe:LIMit[:STATe]	ON   OFF	not SCPI	3.35
:SENSe<n>:POWer:REFlection:RANGe:LOWer	-1999.0..+1999.0   MINimum   MAXimum   DEFault	not SCPI	3.36
:SENSe<n>:POWer:REFlection:RANGe[:UPPer]	-1999.0..+1999.0   MINimum   MAXimum   DEFault	not SCPI	3.36
:SENSe<n>:POWer[:POWer]:RANGe:AUTO	ON   OFF	not SCPI	3.34
:SENSe<n>:POWer[:POWer]:RANGe:LIMit:DETECT	INBound   OUTBound   HIGH	not SCPI	3.34
:SENSe<n>:POWer[:POWer]:RANGe:LIMit[:STATe]	ON   OFF	not SCPI	3.34
:SENSe<n>:POWer[:POWer]:RANGe:LOWer	-1999.0..+1999.0   MINimum   MAXimum   DEFault	not SCPI	3.35
:SENSe<n>:POWer[:POWer]:RANGe[:UPPer]	-1999.0..+1999.0   MINimum   MAXimum   DEFault	not SCPI	3.35
:SENSe<n>:RRESolution	LOW   HIGH	not SCPI	3.31
:SENSe<n>:SWR:LIMit	1..100   MINimum   MAXimum   DEFault	not SCPI	3.37
:SENSe<n>:SWR:SIGNal	NONE   BEEPer   TTLSignal   BOTH	not SCPI	3.37
:SENSe<n>:SWR:SIGNal[:TTLSignal]:LEVel	LOW   HIGH	not SCPI	3.37
:SENSe<n>:SWR:THReshold	0 to 100E6 W   -200 to 200dBm   MINimum   MAXimum   DEFault	not SCPI	3.37
:STATus:OPERation:CONDition?	–		3.38
:STATus:OPERation:ENABLE	0..32767		3.39
:STATus:OPERation:NTRansition	0..32767		3.38
:STATus:OPERation:PTRansition	0..32767		3.38
:STATus:OPERation[:EVENT]?	–		3.38



Command	Parameters	SCPI Info	Page
:STATus:PRESet	–		3.39
:STATus:QUEStionable:CONDition?	–		3.39
:STATus:QUEStionable:ENABle	0..32767		3.39
:STATus:QUEStionable:NTRansition	0..32767		3.39
:STATus:QUEStionable:PTRansition	0..32767		3.39
:STATus:QUEStionable[:EVENT]?	–		3.39
:STATus:QUEue[:NEXT]?	–		3.39
:SYSTem:BEEPer:STATe	ON   OFF		3.40
:SYSTem:COMMunicate:GPIB[:SELF]:ADDRess	0..31		3.40
:SYSTem:COMMunicate:SERial:CONTrol:RTS	OFF   IBFull   RTS		3.41
:SYSTem:COMMunicate:SERial[:RECeive]:PACE	XON   NONE		3.41
:SYSTem:COMMunicate[:RECeive]:BAUD	1200   2400   4800   9600   MINimum   MAXimum   DEFault		3.41
:SYSTem:ERRor?	–		3.41
:SYSTem:PRESet	–		3.41
:SYSTem:VERSIon?	–		3.41
:TEST:DIRect[?]	"Sensor command"		3.43
:TEST:FRAM?	–		3.42
:TEST:RAM?	–		3.42
:TEST:ROM?	–		3.42
:TEST:SENSor?	–		3.43
:TEST[:ALL]?	–		3.42
:TRIGger[:TRIGger]:SOURce	INTernal   EXTernal	not SCPI	3.44
:TRIGger[:TRIGger][:IMMediate]	–		3.44
:UNIT<n>:POWer	W   DBM		3.45
:UNIT<n>:POWer:REFLection	RCO   RL   SWR   RFR	not SCPI	3.46
:UNIT<n>:POWer:RELative	PCT   DB	not SCPI	3.45
:UNIT<n>:POWer:RELative:STATe	ON   OFF	not SCPI	3.45



## Annex D Programming Examples

The following examples explain how to programme the instrument and can serve as a basis to solve more complex programming tasks.

QuickBASIC was used as programming language. However, the programs can be translated into other languages.

### Annex D.1 Including IEC-Bus Library for QuickBasic

```
REM ----- General Declarations -----
COMMON SHARED sensor%
DECLARE SUB IECOUT (out$)
DECLARE SUB IECIN (read$)

REM ----- Include IEC-bus library for QuickBasic
'$INCLUDE: 'c:\testtool\qbasic\qbdecl.bas'
REM*****
```

### Annex D.2 Initialization and Default Status

The IEC bus as well as the settings of the instrument are brought into a defined default status at the beginning of every program. Subroutines "InitController" and "InitDevice" are used to this effect.

#### Annex D.2.1 Initialize Controller

```
REM ----- Initialize Controller -----
REM InitController
iecaddress% = 28           'IEC-bus address of device,
CALL IBFIND("DEV1", sensor%) 'Open port to the instrument.
CALL IBONL(sensor%, 1)
CALL IBPAD(sensor%, iecaddress%) 'Inform controller about instrument
                                'address.
CALL IBCLR(sensor%)         'Reset IEC-operation of the
                                'instrument,
CALL IBEOS(sensor%, 0)     'Reception terminated by EOI
                                'signal,
CALL IBEOT(sensor%, 1)    'EOI is set with last character
                                'to be sent,
CALL IBTMO(sensor%, T3s)  'Set response time to 1 sec.
REM*****
```

#### Annex D.2.2 Functions for Receiving and Sending Data and Commands

```
REM ----- Functions for receiving and sending -----
REM ----- data and commands -----

REM ----- Read data from IEC/IEEE-bus -----
SUB IECIN (read$)
    temp$ = SPACE$(100)           'Delete domain,
    CALL IBRD(sensor%, temp$)    'Read data from IEC-bus.
```

```

        i% = INSTR(temp$, CHR$(&HA))           'Search NL
        read$ = LEFT$(temp$, i% - 1)         'and discard the rest.
END SUB

REM ----- Output on IEC-bus -----
SUB IECOUT (out$)
    wrt$ = out$ + CHR$(&HD) + CHR$(&HA)
    CALL IBWRT(sensor%, wrt$)
REM*****
END SUB
REM*****

```

### Annex D.2.3 Initialize the Instrument

The IEC-bus status registers and instrument settings of the NRT are brought into the default status.

```

REM ----- Initialize the instrument -----
REM InitDevice
CALL IECOUT("*CLS")           'Reset status registers,
CALL IECOUT("*RST;*WAI")     'Reset the instrument.
REM*****

```

### Annex D.3 Sending Device Setting Commands

The correction frequency is set in this example. Moreover, the sensor connectors are configured, the sensor is set to automatic recognition of the forward direction and the measurement is to be performed on the load side of the sensor. The average of the power is selected as measured quantity. The incident power is displayed in units of percent and is referred to a value of 25 Watt.

```

REM ----- Device setting commands -----
CALL IECOUT("SENS1:FUNC:CONC OFF")           'Non-concurrent functions
CALL IECOUT("SENS1:FREQUENCY 250E6")        'Frequency 250 MHz,
                                           'Automatic Recognition of
                                           'forward direction,
CALL IECOUT("INPUT1:PORT:SOURCE:AUTO ON")    'Reference plane on load side.
CALL IECOUT("INPUT1:PORT:SOURCE:POSITION LOAD")
CALL IECOUT("SENSE1:POWER:REFERENCE 25W")    'Reference power 25W,
                                           'Switch on average measurement.
CALL IECOUT("SENSE1:FUNCTION:ON 'POWER:FORWARD:AVERAGE'")
                                           'Forward units: %.
CALL IECOUT("UNIT1:POWER:RELATIVE PCT;REL:STATE ON")
REM*****

```

### Annex D.4 Switchover to Manual Control

```

REM ----- Switch instrument to manual control -----
CALL IBLOC(sensor%)           'Set instruments to local state.
REM*****

```

## Annex D.5 Reading out Device Settings

The settings made in the example of Annex D. Annex D.3 are read out here. The abbreviated commands are used.

```

REM ----- Read out device settings -----
CALL IECOUT("FREQ?")           'Request frequency settings,
CALL IECIN(CRfrequency$)      'input value.

CALL IECOUT("INP1:PORT:SOUR:AUTO?") 'Request definition of forward
CALL IECIN(Direction$)       'direction,
                               'input value.

CALL IECOUT("INP1:PORT:POS?")   'Request def. of reference plane,
CALL IECIN(Measpos$)           'input value.

CALL IECOUT("SENS1:POW:REF?")   'Request reference value of
CALL IECIN(Reference$)         'forward power,
                               'input value.

CALL IECOUT("SENS1:FUNC:STAT? 'POW:FORW:AVER'") 'Request status of average
CALL IECIN(FunctionState$)     'measurement,
                               'input value.

CALL IECOUT("UNIT1:POW:REL?")   'Request relative unit,
CALL IECIN(Unit$)              'input value.

CALL IECOUT("UNIT1:POW:REL:STAT?") 'Request unit status,
CALL IECIN(UnitState$)         'input value.

REM ----- Display values on screen -----
PRINT "CR frequency: "; CRfrequency$
PRINT "Forward direction: "; Direction$
PRINT "Reference plane: "; Measpos$
PRINT "Reference value: "; Reference$
PRINT "Status for average measurement: "; FunctionState$
PRINT "Relative unit: "; Unit$
PRINT "Relative unit active: "; UnitState$

REM*****

```

## Annex D.6 Performing a measurement

```

REM ----- Example for performing a measurement -----
CALL IECOUT("SENS1:FUNC:CONC OFF") 'Only one measuring function can
                                   'be active.

CALL IECOUT("SENS1:FUNC 'POW:FORW:AVER:BURS'") 'Switch on average burst measurement
                                                'function.

REM ----- Perform measurements -----
NumberMeasurements% = 10
FOR I% = 0 TO NumberMeasurements%
    CALL IECOUT("SENS1:DATA? 'POW:FORW:AVER:BURS'") 'Request result arrived
                                                    'last.

    CALL IECIN(Result$) 'Call result.

REM ----- Display Result -----
PRINT "Result: "; I%; ": "; Result$
NEXT I%
REM*****

```

## Annex D.7 Command Synchronization

The options for synchronization implemented in the following example are described in Section 3.6.6, Befehlsreihenfolge und Befehlssynchronisation.

```

REM ---Examples for Command Synchronization: -----
REM ---The command TRIGer:trigger:immediate requires a relatively long execution
REM ---time (sensor-dependent). It should be ensured that the next command is only
REM ---executed after the result of the measurement has been obtained.

CALL IECOUT("SENS1:FUNC:CONC OFF")           'Only one measuring function must be
                                           'active.

CALL IECOUT("SENS1:FUNC 'POW:FORW:AVER:BURS'") 'Switch on Average Burst
                                           'measuring function.

REM ----- First option: Use of *WAI -----
CALL IECOUT("TRIG; *WAI; :SENS1:DATA? 'POW:FORW:AVER:BURS'")
CALL IECIN(Value$)
PRINT "Measured value TRIG WAI: ";Value$

REM ----- Second option: Use of *OPC? -----
CALL IECOUT("TRIG; *OPC?")
REM ----- here the controller can service other devices ---
CALL IECIN(OpcOk$)
                                           'Wait for "1" from *OPC?
                                           'i. e. the triggered measured result
                                           'is available,
                                           'only then the result can be
                                           'read out.

CALL IECOUT("SENS1:DATA? 'POW:FORW:AVER:BURS'")
CALL IECIN(Value$)
PRINT "Measured value TRIG *OPC?: "; Value$

REM ----- Third option: Use of *OPC -----
REM ---In order to use the service request function with National Instruments
REM ---GPIB driver, the setting "Disable Auto Serial Poll" must be changed to
REM ---"yes" by means of IBCONF!
CALL IECOUT("*SRE 32")
                                           'Enable service request for ESR,
CALL IECOUT("*ESE 1")
                                           'Set event enable bit for
                                           'operation complete bit.

ON PEN GOSUB OpcReady
                                           'Initialize service
                                           'request routine.

PEN ON
CALL IECOUT("TRIG; *OPC")
REM ----- Continue main program -----
STOP
                                           'End of program.

OpcReady:
REM --- As soon as the result of the measurement has been obtained, this subroutine
REM --- is activated.
REM --- Program reaction suitable for the OPC service request, e. g.:

CALL IECOUT("SENS1:DATA? 'POW:FORW:AVER:BURS'")
CALL IECIN(Value$)
RETURN
REM*****

```

## Annex D.8 Service Request

The service request routine requires an extended initialization of the instrument in which the respective bits of the transition and enable registers are set.

In order to use the service request function in conjunction with a National Instruments GPIB driver, the setting "Disable Auto Serial Poll" must be changed to "yes" by means of IBCONF.

```

REM ----- Example of initialization of the SRQ in the case of errors --
CALL IECOUT("*CLS")           'Reset Status Reporting System,
CALL IECOUT("*SRE 168")      'Enable service request for
                              'STAT:OPER-,STAT:QUES- and ESR-
                              'registers,
CALL IECOUT("*ESE 61")       'Set Event-Enable bit for
                              'command execution,device
                              'dependent and query errors,
CALL IECOUT("STAT:OPER:ENAB 32767") 'Set OPERATION Enable Bit
                              'for all events,
CALL IECOUT("STAT:OPER:PTR 32767") 'Set associated OPERATION
                              'Ptransition bits,
CALL IECOUT("STAT:QUES:ENAB 32767") 'Set Questionable Enable bits
                              'for all events,
CALL IECOUT("STAT:QUES:PTR 32767") 'Set associated Questionable
                              'Ptransition bits,
ON PEN GOSUB Srq             'Initialize service
                              'request routine.

PEN ON
REM ----- Continue main program here -----
STOP                         'End of program
REM*****

Srq:
REM ----- Service Request Routine -----
DO
  SRQFOUND% = 0
  FOR I% = UserN% TO UserM%   'Poll all bus users.
    ON ERROR GOTO noUser      'No user existing.
    CALL IBRSP(I%, STB%)      'Serial Poll, read Status Byte,
    IF STB% > 0 THEN          'This instrument has bits set
                              'in the STB.
      SRQFOUND% = 1
      IF (STB% AND 16) > 0 THEN GOSUB Outputqueue
      IF (STB% AND 4) > 0 THEN GOSUB Failure
      IF (STB% AND 8) > 0 THEN GOSUB Questionablestatus
      IF (STB% AND 128) > 0 THEN GOSUB Operationstatus
      IF (STB% AND 32) > 0 THEN GOSUB Esrread
    END IF
  NEXT I%
noUser:
  NEXT I%
LOOP UNTIL SRQFOUND% = 0
ON ERROR GOTO Errorhandling
ON PEN GOSUB Srq: RETURN     'Enable SRQ routine again;
                              'End of SRQ routine.
REM*****

REM ----- Subroutines for the individual STB bits -----
Outputqueue:                 'Reading the output buffer.
CALL IECIN(Message$)
PRINT "Message in output buffer: "; Message$
RETURN

```

```

Failure:                                     'Read error queue.
CALL IECOUT("SYSTEM:ERROR?")
CALL IECIN(ERROR$)
PRINT "Error text: "; ERROR$
RETURN

Questionablestatus:                         'Read Questionable Status register.
CALL IECOUT("STATUS:QUESTIONABLE:EVENT?")
CALL IECIN(Ques$)
IF (VAL(Ques$) AND 8) > 0 THEN PRINT "Power ranging control"
                                     'Power value questionable,
IF (VAL(Ques$) AND 512) > 0 THEN PRINT "SWR-warning"
                                     'Standing wave ratio questionable,
IF (VAL(Ques$) AND 1024) > 0 THEN PRINT "Sensor warning"
IF (VAL(Ques$) AND 2048) > 0 THEN PRINT "Burst parameters invalid"
RETURN

Operationstatus:                             'Read Operation-Status register.
CALL IECOUT("STATUS:OPERATION:EVENT?")
CALL IECIN(Oper$)
IF (VAL(Oper$) AND 2) > 0 THEN PRINT "Initializing sensor"
IF (VAL(Oper$) AND 16) > 0 THEN PRINT "Measurement started"
IF (VAL(Oper$) AND 32) > 0 THEN PRINT "Waiting for trigger"
IF (VAL(Oper$) AND 256) > 0 THEN PRINT "Battery operation"
IF (VAL(Oper$) AND 512) > 0 THEN PRINT "Determination of max./min values active"
RETURN

Esrread:                                     'Read Event-Status register,
CALL IECOUT("*ESR?")                       'Read ESR.
CALL IECIN(Esr$)
IF (VAL(Esr$) AND 1) > 0 THEN PRINT "Operation complete"
IF (VAL(Esr$) AND 4) > 0 THEN GOTO Failure
IF (VAL(Esr$) AND 8) > 0 THEN PRINT "Device dependent error"
IF (VAL(Esr$) AND 16) > 0 THEN GOTO Failure
IF (VAL(Esr$) AND 32) > 0 THEN GOTO Failure
IF (VAL(Esr$) AND 64) > 0 THEN PRINT "User request"
IF (VAL(Esr$) AND 128) > 0 THEN PRINT "Power on"
RETURN
REM *****

REM ----- Error routine -----
Errorhandling:
PRINT "ERROR"                               'Output error message,
STOP                                         'Abort program.
REM*****
REM*****

```



## Annex E Default Settings

The columns **Preset NRT** and **Preset Sensor** of the following table indicate the default state of the stored parameters which is activated after a reset (RECALL 0 in manual operation or \*RST, RCL 0, SYSTem:PRESet in remote control). The state **Factory Preset** which is set after a firmware upgrade with extension of the database (additional parameters) is also given. → Sensor identifies a sensor-specific parameter whose default state can be read out from the sensor.

The columns **Manual operation** and **Remote control** indicate the path for setting the concerned parameter. If the description of the default state in remote control differs from that in manual operation, this is separately identified by <x> ≡ or <y> ≡.

**Table E-1 Default Settings**

Parameter	Preset NRT	Preset Sensor -Z43 -Z44	Factory Preset NRT	Manual operation					Remote control
				Key	1st level	2nd level	3rd level	4th level	Remote-control command
Power measurement function	<b>AVG</b>	---	AVG	AVG / ENV					no equivalent
Unit (power)	<b>W</b>	---	W	dBm / Δ / W					:UNIT<n>:POWer:RELative:STATe OFF :UNIT<n>:POWer <x>
SWR measurement function	<b>SWR</b>	---	SWR	SWR / RFL					:UNIT<n>:POWer:REFLection <x>
Autoranging (bargraphs)	<b>ON</b>	---	ON	SCALE < > - AUTO -					:SENSe<n>:POWer[:POWer]:RANGe:AUTO <x> :SENSe<n>:POWer:REFLection:RANGe:AUTO <x>

Parameter	Preset NRT	Preset Sensor -Z43 -Z44	Factory Preset NRT	Manual operation					Remote control
				Key	1st level	2nd level	3rd level	4th level	Remote-control command
Envelope measurement function	AV.BRST	---	AV.BRST	CONF	ENV KEY				no equivalent
Burst mode	USER	---	USER	CONF	ENV KEY	AV.BRST			:SENSe<n>:BURSt:MODE <x>
Burst width	→ Sensor	0.001	0.005	CONF	ENV KEY	AV.BRST	USER	WIDTH	:SENSe<n>:BURSt:WIDTh <x>
Burst period	→ Sensor	0.010	0.01	CONF	ENV KEY	AV.BRST	USER	PERIOD	:SENSe<n>:BURSt:PERiod <x>
Video bandwidth	→ Sensor	FULL <x> ≡ 2	---	CONF	ENV KEY	PEP CF CCDF	VID.BW		:SENSe<n>:BANDwidth:VIDeo:FNUMber <x>
CCDF threshold	→ Sensor	1 W	---	CONF	ENV KEY	CCDF	CCDF. REF		:SENSe<n>:POWer:CCDFfunction:REFerence <x>
Power display (FWD / F-R)	FWD	---	FWD	CONF	POWER				no equivalent
Maximum value display	OFF	---	OFF	CONF	MAXHOLD				:CALCulate<n>:LIMit[STATe] <x>
Type of limit value	MAX	---	MAX	CONF	MAXDISP				:CALCulate<n>:LIMit:TYPE <x>
Lower scale end value	0.0	---	0.0	CONF	SCALE	POWER REFL	LOWER		:SENSe<n>:POWer[:POWer]:RANGe:LOWer <x> :SENSe<n>:POWer:REFLection:RANGe:LOWer <x>
Upper scale end value	1.0	---	1.0	CONF	SCALE	POWER REFL	UPPER		:SENSe<n>:POWer[:POWer]:RANGe:UPPer <x> :SENSe<n>:POWer:REFLection:RANGe:UPPer <x>

Parameter	Preset NRT	Preset Sensor -Z43 -Z44	Factory Preset NRT	Manual operation					Remote control
				Key	1st level	2nd level	3rd level	4th level	Remote-control command
Resolution	→ Sensor	<b>LOW</b>	LOW	CONF	RESOL				:SENSe<n>:RRESolution <x>
Integration time	→ Sensor	<b>0.037 s</b>	---	CONF	INT.TIME				:SENSe<n>:POWer:APERture <x>
Reference value	<b>1 W</b>	---	1 W	CONF	SPEC	ΔREF			:SENSe<n>:POWer:REFerence <x>
SWR alarm (max. SWR)	<b>3.0</b>	---	3.0	CONF	SPEC	SWR. ALARM	MAX SWR		:SENSe<n>:SWR:LIMit <x>
SWR alarm (threshold)	<b>100 MW</b>	---	100 MW	CONF	SPEC	SWR. ALARM	THRES HOLD		:SENSe<n>:SWR:THReshold <x>
Relative display	<b>dB</b>	---	dB	CONF	Δ KEY				:UNIT<n>:POWer:RELative <x>
Reflection measurement function (as an alternative to SWR)	<b>RL</b>	---	RL	CONF	RFL KEY				no equivalent
Correction frequency (NRT-Z)	→ Sensor	<b>1E9Hz</b>	→ Sensor	CORR	FREQ				:SENSe<n>:FREQuency[:CW FIXED] <x>
Correction frequency (NAP-Z)	<b>DEF</b>	---	DEF	CORR	FREQ				:SENSe<n>:FREQuency[:CW FIXED] <x>
Modulation correction	<b>OFF</b>	---	OFF	CORR	MODULATION				:SENSe<n>:DM:STATe <x>
Chip rate	→ Sensor	<b>4.096E6</b>	---	CORR	MODULATION	WCDMA	CHIP. RATE		:SENSe<n>:DM:WCDMa:CRATe <x>
Reference plane	→ Sensor	<b>LOAD</b>	LOAD	CORR	MEAS.POS				:INPut<n>:PORT:POSItion <x>

Parameter	Preset NRT	Preset Sensor -Z43 -Z44	Factory Preset NRT	Manual operation					Remote control
				Key	1st level	2nd level	3rd level	4th level	Remote-control command
Cable attenuation	→ Sensor	0 dB	---	CORR	MEAS.POS	LOAD SOURCE	OFFSET		:INPut<n>:PORT:OFFSet <x>
Forward direction	→ Sensor	<b>AUTO</b> <x> ≡ <b>ON</b>	1→ 2 <x> ≡ OFF <y> ≡ 1	CORR	DIRECTION				:INPut<n>:PORT:SOURce:AUTO <x> :INPut<n>:PORT:SOURce <y>
Display lighting	<b>OFF</b>	---	OFF	UTIL	ILLUM				cannot be remote-controlled
ON time in battery operation	<b>5MIN</b> <x> ≡ 300s	---	5MIN <x> ≡ 300s	UTIL	AUTO.OFF				:CONTRol:POWer[:STATe] ON :CONTRol:POWer:DELay <x>
Mode after charging	<b>RUN</b>	---	RUN	UTIL	AFTER CHARGE				:CONTRol:POWer:BATTery:ACHarge <x>
Beeper	<b>SWR. ALARM</b> <x> ≡ <b>BEEPer</b>	---	SWR.ALAR M<x> ≡ BEEPer	UTIL	BEEPER				:SYSTem:BEEPer:STATe OFF :SENSe<n>:SWR:SIGNal <x>
Remote control interface	<b>IEC</b>	---	IEC	UTIL	REMOTE				cannot be remote-controlled
IEC/IEEE-bus address	<b>no change</b>	---	12	UTIL	REMOTE	IEC	IEC. ADR		:SYSTem:COMMunicate:GPIB[:SELF]:ADDRess <x>
Baud rate	<b>no change</b>	---	9600	UTIL	REMOTE	RS232	BAUD		:SYSTem:COMMunicate:SERial[:RECeive]:BAUD <x>
Handshake mode	<b>no change</b>	---	XON/XOFF <x> ≡ OFF <y> ≡ XON	UTIL	REMOTE	RS232	MODE		:SYSTem:COMMunicate:SERial:CONTRol:RTS <x> :SYSTem:COMMunicate:SERial[:RECeive]:PACE <y>

Parameter	Preset NRT	Preset Sensor -Z43 -Z44	Factory Preset NRT	Manual operation					Remote control
				Key	1st level	2nd level	3rd level	4th level	Remote-control command
Monitoring criterion for bargraphs (AUX/TTL connector)	<b>HIGH</b>	---	HIGH	UTIL	AUX/IO	OUT	POWER REFL	PWR RFL	:SENSe<n>:POWer[:POWer]:RANGe:LIMit:DETECT <x> :SENSe<n>:POWer:REFlection:RANGe:LIMit:DETECT <x>
Output level for SWR alarm (AUX TTL connector)	<b>HIGH</b>	---	HIGH	UTIL	AUX/IO	SWR. ALARM	LOGIC LEVEL		:SENSe<n>:SWR:SIGNal[:TTLSignal]:LEVel <x>
Display frequency/attenuation	<b>OFFS/FREQ</b>	---	OFFS/FREQ	UTIL	SHOW				cannot be remote-controlled



# Index

## A

A/D-converter	
integration time	2.26
AC supply voltage	1.4
Accessories	5.1
Accuracy	2.30
Acoustic acknowledgement signal	2.43
Address	
IEC-bus	3.3
Addressed commands	A.3
AFTER CHARGE	2.42
AUTO mode	2.12
AUTO OFF	3.24
Automatic recognition of forward direction	3.27
Autoscaling	2.12
AUXiliary connector	2.45
Average burst power	2.3
AUTO	2.20
USER	2.20
Average measurement	2.17

## B

Backlighting (display)	2.40
Bargraph	2.24
scale	2.24
scaling	2.12
select	2.46
Basic unit	3.33
Battery	
automatic switch-off	1.11
Automatic switchoff	2.42
charge	1.8, 2.43, 4.2
Charging	2.42
counter	1.11
manual charging	1.9
operation (option NRT-B3)	1.8
replace	4.1
replacement	1.12
save energy	1.10
spare	4.1
storage	4.2
time	2.42
Baud rate (RS-232-C)	3.41, A.5
Beeper	2.15, 3.40
BEEPER	2.43
Boolean parameter	3.11
Brief instructions	3.1
Built-in test	2.48
Burst	2.20
period	2.21, 3.30
width	2.21, 3.30

## C

Cable loss	2.35, 2.48
Calibration data	2.6
Calibration dataset	2.32
Calibration factors	2.32, 2.37
Carrier frequency	2.31, 3.31
CCDF	2.18
CF	2.17
Character data	3.10
Charging control	3.24
Cleaning the outside	4.1

## Command

addressed	A.3
line structure	3.9
parameter	3.10
recognition	3.48
sequence	3.49
structure	3.6
synchronization	3.49
syntax elements	3.12
universal	A.3
Common commands	3.6, 3.7, 3.18
Competitive measurement functions	3.31
Complementary cumulative distribution function	2.4
CONDition register	3.38, 3.39, 3.51
CONFIg menu	2.16
Configuration	
IN/OUT connector	2.45
interfaces and memories	2.13, 2.39
power Indication	2.23
reflection indication	2.29
relative units	2.28
Connection to AC supply	1.4
Connector	
configuration	2.36
Control lines (IEC-Bus)	A.2
Correction frequency	2.31, 2.48
Crest Factor	2.3, 2.17, 2.19

## D

Data bit (RS-232-C)	A.5
Data lines (IEC/IEEE-bus)	A.1
Data set	3.48
Data terminal equipment	3.41
DCL	3.47
Decimal point	3.10
Default setup	2.1, 2.40, E.1
Default status	3.20
Delimiter	3.47
Device address	2.44
Device settings	
Load	3.20
Device test	2.48
Device-specific commands	3.7
Difference search	2.23
Display board	4.14
Display range	2.4
Display symbol	
F-R	2.23
FWD	2.23
Display test	2.48
Duty cycle	2.20

## E

Elapsed time meter	2.49, 3.25
EMC shielding measures	1.6
ENABLE register	3.39, 3.51
Envelope parameters	2.17
average	2.18
average burst	2.18
CCDF	2.18, 2.22
CF	2.17
cumulative distribution function	2.22
measuring example	2.3
peak envelope power	2.17
PEP	2.17

- EOI (command line).....3.9  
 Error messages ..... 3.39, 3.41 see Annex B  
   device-specific..... B.8  
   SCPI..... B.1  
 Error queue..... 3.39, 3.41, 3.57  
 ESE (event status enable register) .....3.54  
 EVENT register..... 3.38, 3.39  
 Event status enable register (ESE).....3.54  
 Exponent .....3.10
- F**
- Firmware  
   load .....4.3  
   update .....4.3  
 FIXED mode.....2.12  
 Forward direction.....2.36, 3.26  
 Forward power.....2.29  
 F–R (forward – reverse power).....2.23  
 Frequency response correction.....2.5, 2.31  
   NAP sensors .....2.32  
   NRT sensors .....2.31  
 Front view.....1.2  
 Function parameters.....2.15  
 Function test.....1.6  
 Functional test.....4.8  
 FWD (forward power) .....2.23
- G**
- General functions .....2.39  
 GET (Group Execute Trigger).....3.48  
 GPIB.....3.40
- H**
- Handshake (RS-232-C) ..... A.6  
 Header (commands) .....3.6
- I**
- IEC 625.1/IEEE 488.2.....2.44  
 IEC/IEEE bus .....3.40  
   device address .....2.44, 3.3, 3.40  
   interface ..... A.1  
 IN/OUT connector  
   configuration.....2.45  
 Indentations.....3.13  
 Input buffer .....3.47  
 Instrument  
   close.....4.11  
   open .....4.10  
 Instrument configuration .....2.40  
   recall .....2.40  
 Integration time.....2.26  
 Interface ..... See Remote control  
   functions (IEC/IEEE-bus)..... A.2  
   functions (RS-232-C)..... A.5  
   IEC/IEEE-bus ..... A.1  
   messages (IEC/IEEE-bus)..... A.3  
   RS-232-C ..... A.4  
   setting .....2.44  
 Interrupt.....3.53  
 IST flag.....3.19
- K**
- Key  
   AVG/ENV .....2.11  
   dBm/ $\Delta$ W .....2.11  
   SWR/RFL.....2.11
- $\Delta$  REF .....2.11  
 Key words (commands)..... 3.6  
 KEYBOARD LOCK .....2.50  
 Keypad test.....2.48
- L**
- Limit control.....2.28  
 Limits .....2.24  
 List of commands..... see Annex C  
 Load.....2.34  
 Load  
   Device settings .....3.20  
 Long form (commands) .....3.8  
 Lower-case (commands).....3.8
- M**
- Mainboard.....4.14  
 Maintenance .....4.1  
 Maximum  
   search.....2.23  
   store .....2.24  
 Maximum value (commands) .....3.10  
 Measurement accuracy.....2.5, 3.31  
 Measurement function.....3.33  
   activate .....3.32  
   deactivate .....3.32  
 Measuring equipment.....5.1  
 Measuring examples .....2.1  
   envelope parameter .....2.3  
   power differences .....2.2  
   power measurement .....2.2  
   reflection measurement.....2.4  
 Memory test .....2.49  
 Menu  
   CONFig.....2.16  
   CORRection.....2.30  
   notation.....2.15  
   UTILity.....2.39  
 Menu item (Parameter) .....2.13  
 Menu/sub menu  
   SHOW .....2.48  
 Menu/submenu  
   AFTER CHARGE.....2.42  
   AUTO.OFF .....2.41  
   AUX/IO .....2.45  
   AV.BRST .....2.20  
   BATT.TTIME.....2.42  
   BATTERY CHARGE.....2.43  
   BEEPER.....2.43  
   CALDATA .....2.37  
   CCDF.....2.22  
   CF.....2.19  
   CONFig.....2.16  
   CORRection.....2.30  
   DIRECTION.....2.36  
   ELAPSED TIME.....2.49  
   ENV KEY.....2.17  
   FREQ.....2.31  
   ILLUM .....2.40  
   INT.TIME .....2.26  
   LOWER (Scaling) .....2.25  
   MAXDISP .....2.24  
   MAXHOLD.....2.23  
   MEAS.POS.....2.34  
   PEP .....2.18  
   POWER.....2.23  
   RECALL.....2.40  
   REMOTE .....2.44  
   RESOL .....2.25



- RFL KEY ..... 2.29  
 SAVE ..... 2.41  
 SCALE ..... 2.24  
 SETUP ..... 2.40  
 SPEC ..... 2.27  
 SWR.ALARM ..... 2.27  
 TEST ..... 2.48  
 UPPER (Scaling) ..... 2.25  
 UTILITY ..... 2.39  
 VID.BW ..... 2.18  
 ZERO ..... 2.32  
 Δ KEY ..... 2.28  
 Δ REF ..... 2.27
- Messages  
 IEC-bus ..... 3.5  
 RS232 ..... 3.5
- Meter  
 battery time ..... 2.42  
 elapsed time ..... 2.49
- Minimum  
 Minimum search ..... 2.23  
 Minimum value (commands) ..... 3.9  
 Modem bypass ..... 3.41
- Module  
 installation and removal ..... 4.10
- Module exchange  
 display board ..... 4.14  
 mainboard ..... 4.14  
 NRT-B1 ..... 4.11  
 NRT-B2 ..... 4.11  
 NRT-B3 ..... 4.12  
 power supply ..... 4.13
- Monitoring criteria ..... 2.46
- ## N
- NAN ..... 3.10  
 Negative transition filters ..... 3.38, 3.39, 3.51  
 New Line (command line) ..... 3.9  
 NINF ..... 3.10  
 NTRansition register ..... 3.51  
 Numeric entries ..... 2.14  
 Numeric parameters ..... 2.15  
 Numeric suffix ..... 3.8  
 Numerical values ..... 3.10
- ## O
- Operating concept ..... 4.7
- Option  
 installation ..... 1.7  
 list ..... 1.7  
 NRT-B1 ..... 1.5, 4.11  
 NRT-B2 ..... 1.4, 4.11  
 NRT-B3 ..... 1.8, 4.1, 4.12
- Overlapping execution ..... 3.48
- Overview  
 status register ..... 3.52  
 syntax elements ..... 3.12
- ## P
- Parallel poll ..... 3.57  
 Parallel poll enable register (PPE) ..... 3.54  
 Parameter (commands) ..... 3.10
- Parameters  
 function parameters ..... 2.14  
 numeric parameters ..... 2.14  
 selection parameters ..... 2.13
- Parity bit (RS-232-C) ..... A.5  
 Path (commands) ..... 3.7
- Peak envelope power ..... 2.3, 2.17  
 Peak power ..... 2.17  
 PEP ..... see Envelope Parameters  
 Physical quantities ..... 3.9  
 Positive transition filters ..... 3.38, 3.39, 3.51  
 Power differences ..... 2.2  
 Power fuses ..... 1.5  
 Power measurement ..... 2.2  
 forward/absorbed ..... 2.8  
 Power supply ..... 4.13  
 Power up ..... 1.5  
 Power-saving function ..... 3.24  
 PPE (Parallel poll enable register) ..... 3.54  
 Preparation for Use ..... 1.1  
 Programming examples ..... see Annex D  
 PTRansition register ..... 3.51  
 Putting into operation ..... 1.1  
 connect a sensor ..... 1.5  
 connection to AC supply ..... 1.4  
 EMC shielding measures ..... 1.6  
 power up ..... 1.5  
 rackmounting ..... 1.4  
 set up ..... 1.1  
 unpack ..... 1.1
- ## Q
- Query ..... 3.6  
 responses ..... 3.6, 3.9  
 Query of results ..... 3.33
- ## R
- Rackmounting ..... 1.4  
 Rear view ..... 1.3  
 Reference plane ..... 2.8, 3.26  
 definition ..... 2.34  
 Reference value ..... 2.27  
 Reference value for relative indication ..... 2.27  
 Reference value for relative power variation ..... 2.27  
 Reflection measurement ..... 2.4  
 acoustic monitoring ..... 2.4  
 configuration ..... 2.29  
 parameters ..... 2.4  
 Relative indication ..... 2.28
- Remote control  
 select interfaces ..... 2.44
- Remote control ..... 3.1  
 REMOTE state ..... 3.3  
 Reset ..... 3.20, 3.39, 3.41  
 status reporting system ..... 3.58
- Resolution ..... 2.25  
 Responses to queries ..... 3.9  
 Reverse power ..... 2.29  
 RFI power ..... 2.32
- RS-232-C  
 interface ..... A.4
- ## S
- Scaling ..... 2.4  
 bargraphs ..... 2.12
- Scaling ..... 2.24
- SCPI  
 conformity information ..... C.1  
 introduction ..... 3.6  
 status register ..... 3.50  
 version number ..... 3.41
- SCPI commands for  
 configuration of measurement task ..... 3.28  
 configuration of sensor connectors ..... 3.26

general configuration .....	3.40
information on operating state .....	3.25
power supply .....	3.24
selftest .....	3.42
status Reporting System .....	3.38
triggering measurements .....	3.44
Selection parameters .....	2.15
Selftest .....	2.48, 3.20
Sensor .....	1.5
connect .....	2.1
directional .....	2.36
measurement with several .....	2.9
recall configuration .....	2.40
store configuration .....	2.40
Sensor test .....	2.49
Serial interface .....	3.41
Serial poll .....	3.57
Service request (SRQ) .....	3.20, 3.56
SERVICE REQUEST ENABLE .....	3.20
Service request enable register (SRE) .....	3.53
Setting commands .....	3.5
Setting marker .....	2.13
Setting the bargraph .....	2.24
Setting up .....	1.1
Short form (commands) .....	3.8
Short introduction .....	2.1
Sign .....	3.10
Special characters .....	3.14
Special functions .....	2.27
Specifications	
check .....	5.1
Square brackets .....	3.8
SRE (service request enable register) .....	3.53
SRQ (service request) .....	3.20, 3.56
Standby .....	1.5, 2.41
Standing wave ratio .....	2.29
Start bit (RS-232-C) .....	A.5
Status byte .....	3.39
Status byte (STB) .....	3.39, 3.53
Status register	
overview .....	3.52
structure .....	3.50
Status registers .....	3.38
Status reporting system .....	3.50
STATus:OPERation register .....	3.55
STATus:QUESTionable register .....	3.55
STB (status byte) .....	3.53
Stop bit (RS-232-C) .....	A.5
Structure	
command .....	3.6
command line .....	3.9
Sum bit .....	3.51
Switchover to remote control .....	3.3
SWR alarm .....	2.47
SWR LIMIT .....	2.28
SWR monitoring .....	2.27
<b>T</b>	
Test report .....	5.8
Test setup .....	2.1
Tests	
display test .....	2.48
keypad test .....	2.48
memory test .....	2.49
sensor test .....	2.49
Threshold detector .....	2.46
Transmission rate .....	3.41
Troubleshooting .....	4.8
modules .....	4.8
<b>U</b>	
Underrange identification .....	2.12
Unfiltered setting commands .....	3.42
Unit .....	3.9
Units	
configuration .....	2.28
relative power [%] .....	2.28
relative power level [dB] .....	2.28
Universal commands .....	A.3
Unpacking .....	1.1
<b>V</b>	
Video bandwidth .....	2.18, 2.21, 2.22, 3.30
<b>Z</b>	
Zero error .....	2.32
Zeroing .....	2.7, 2.32